

AHUJA[®]

Hallmark of Reliability!

80 YEARS

1940-2020



PROFESSIONAL SOUND REINFORCEMENT SOLUTIONS

Product Catalogue 2021-22

NOSTALGIA





A.N. Ahuja

Founder Ahuja Group
1916-2007

AHUJA is today at the threshold of a most defining moment in the history of professional audio, perhaps anywhere in the world. Having completed 81 glorious years of a trail-blazing stature, AHUJA is poised more than ever before to advance towards its centenary.

Eight decades of constant progress and undiminished customer and user loyalty have bestowed us with a legendary past and an inspiring future.

What makes AHUJA as the the first brand with recall value in the minds of users and contemporaries is not simply what AHUJA does, but how it does - with a boldness that inspires the entire Pro Audio industry.

It is a potent mix of the three “E”s

Enthusiasm - To tread in hitherto unexplored avenues of PA / Pro Audio and turn every challenge and every obstacle into an opportunity

Excitement - To remain the pioneers and leaders in the industry

Energy - To persevere and persist in the pursuit of excellence in every act, to always seek “perfect sound”

AHUJA has always believed in raising the bar, and it is likely to keep going up. Every AHUJA product in this catalogue is painstakingly made to not only deliver, but exceed users expectations.

Because our motto is to make high quality reliable products utilising the technical expertise and know-how accumulated over the years. For this, we are constantly improving and perfecting our technological capabilities, to ensure that you, our valued patron, get nothing but the best.

Built Brick by Brick...



From a modest beginning way back in 1940, AHUJA products today are manufactured in modern, well-equipped factories in Delhi and Noida. A large strength of engineers, technicians and skilled workers are involved in the manufacture of AHUJA Sound Reinforcement products. Today, AHUJA makes the widest range of Professional Audio products to meet every conceivable application requirement.

RESEARCH & DEVELOPMENT

The AHUJA Research and Development Centre is recognised by the Government of India since 1976 and takes pride in developing products known to perform with absolute reliability even in the most extreme operating & climatic conditions.

COUNTRY WIDE SALES NETWORK AND WORLD WIDE EXPORTS

In India AHUJA products are sold through a network of over 550+ retailers. AHUJA products are the preferred choice of discerning users in over 45 Countries in 5 Continents.

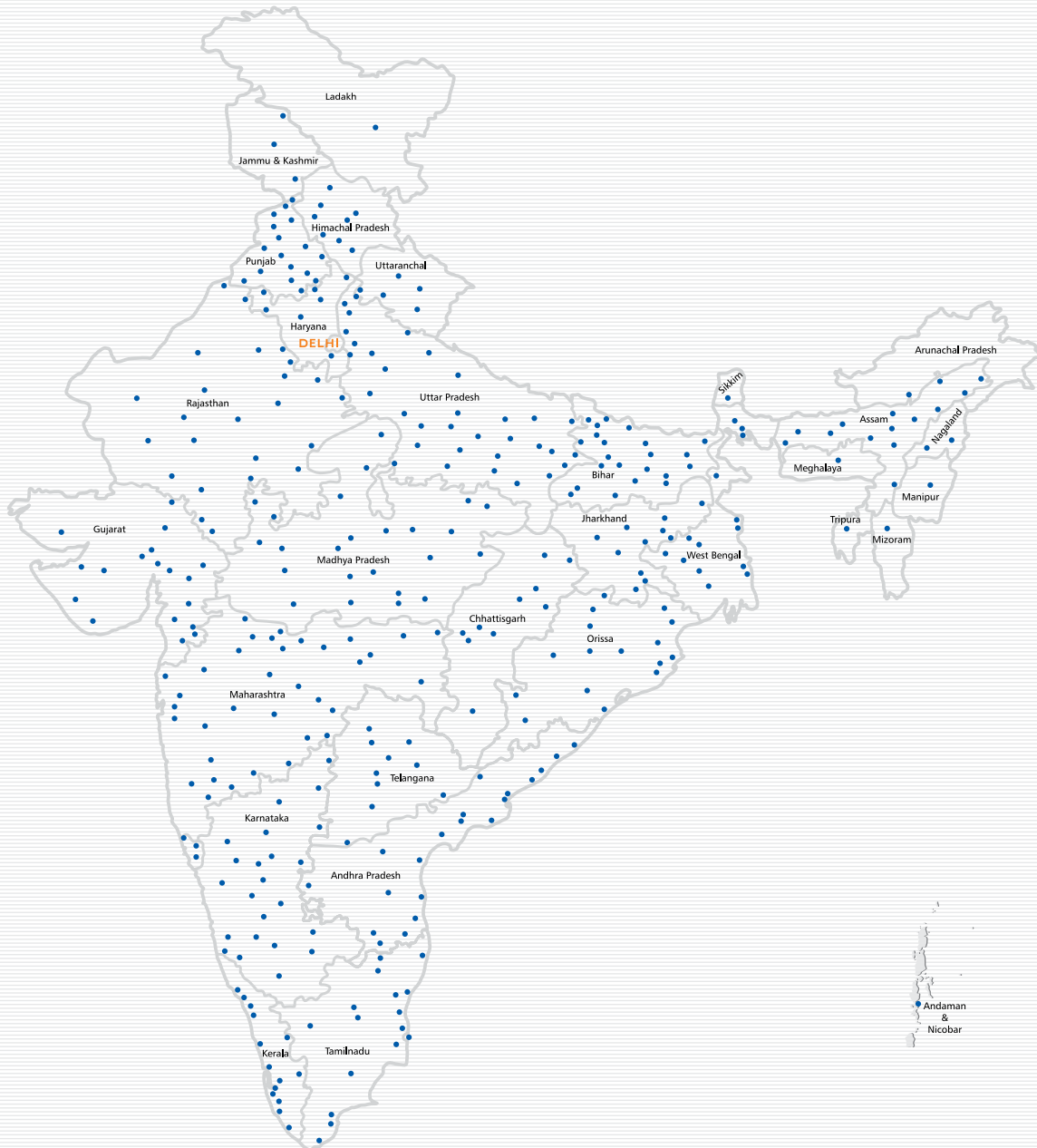

AHUJA PRODUCTS ARE EXPORTED AND SOLD IN OVER 45 COUNTRIES

- Asia:** Bangladesh | Bhutan | Myanmar | Nepal | Singapore | Sri Lanka | Thailand
- Middle East:** Bahrain | Iraq | Jordan | Kuwait | Lebanon | Oman | Qatar | Saudi Arabia | Syria | U.A.E. | Yemen
- Europe:** Austria | France | Germany | Italy | Norway | Poland | Spain | U.K.
- Africa:** Algeria | Djibouti | Egypt | Ethiopia | Ghana | Kenya | Libya | Malawi | Mauritius | Morocco | Mozambique | Nigeria | Senegal | South Africa | Sudan | Tanzania | Uganda
- Oceania:** Australia | Fiji
- Americas:** Trinidad



An ISO 9001:2015 Co.

AHUJA'S PIONEERING EFFORTS

EXCELLENCE IN ELECTRONICS & IT



Mr. Vikram Ahuja, Vice President, Ahuja Radios, receiving the Award from the then Minister for Information Technology, in recognition of Excellence in Electronics & IT, for the year 2007-2008.

NATIONAL QUALITY AWARD



Mr. Sandeep Ahuja, Sr. Vice President, Ahuja Radios, receiving the National Quality Award in October 2006 from Sh. Pranab Mukherjee, the then Defence Minister.

AWARD FOR HIGHEST EXPORT



Mr. A.N. Ahuja, Founder President, Ahuja Radios, receiving the Award in February 2005 from Sh. Dayanidhi Maran, the then Union Minister for Information Technology, in recognition of Highest Exports in Consumer Electronics in SSI Sector.

AWARD FOR LIFETIME ACHIEVEMENT



Mr. A.N. Ahuja, Founder President, Ahuja Radios, receiving the Lifetime Achievement Award from Sh. Balram Jakhar, Ex-Speaker, Lok Sabha, in 2004.

AWARD FOR HIGHEST EXPORT



Mr. A.N. Ahuja, Founder President, Ahuja Radios, New Delhi, receiving the Award from Sh. Arun Shourie, the then Minister of Communication and Information Technology in recognition of Highest Export, in 2002.

AWARD FOR HIGHEST EXPORT



Mr. N.S. Ahuja, Partner, Prosound Products receiving the Award from Sh. Arun Shourie, the then Minister of Communication and Information Technology in recognition of Highest Export, in 2001.

AWARD FOR EXCELLENCE IN ELECTRONICS



Mr. N.S. Ahuja, President, Ahuja Radios, receiving the Award from Sh. Pramod Mahajan, the then Minister for Information Technology in recognition of Excellence in Electronics, for 1999-2000.

AWARD FOR EXCELLENCE IN EXPORT



Mr. Sandeep Ahuja, Sr. Vice President, Ahuja Radios, receiving the Award for Excellence in Exports. The Prestigious Award from the Computer & Software Export Promotion Council was presented by Sh. Pramod Mahajan, the then Minister for Information Technology, for 1999-2000.

AWARD FOR EXCELLENCE IN EXPORT



Mr. Arjun Ahuja, Vice President, Ahuja Radios, receiving the Award from Sh. Pramod Mahajan, the then Minister for Information Technology, for 1998-1999.

AWARD FOR HIGHEST EXPORT



Mr. A.N. Ahuja, Founder President, Ahuja Group, receiving Award from the then Prime Minister, Sh. Atal Behari Vajpayee, for Highest Export in Consumer Electronics, for 1997-1998.

AWARD FOR EXCELLENCE IN EXPORT



Mr. Vikram Ahuja, Vice President, Ahuja Radios, receiving Award from the then Prime Minister, Sh. Atal Behari Vajpayee, for Excellence in Export in Consumer Electronics, in 1997.

AWARD FOR EXPORT PERFORMANCE



Mr. Pradeep Ahuja, Partner, Prosound Products, Mumbai receiving Award from the then Minister for External Affairs, Sh. Pranab Mukherjee, for Outstanding Export Performance, in 1995-1996.

Contents

Conference Systems

CWS-8000 Series	8
CM-5000 Series	10
CM-4000 Series	13

Amplifiers

Dual Channel Power Amplifiers	16
Two Zone PA Power Amplifiers	21
Two Zone PA Mixer Amplifiers	22
DJ & PA Power Amplifiers	25
PA Power Amplifiers	27
PA Mixer Amplifiers	30
Mobile PA Amplifiers	36
Installation PA Amplifiers	38
Installation PA Mixer with Digital Player	39
PA Audio Splitters	40
Digital Player/Recorder	40

PA Amplifiers with built-in Digital Player

Dual Channel Power Amplifier with Digital Player	42
DJ & PA Power Amplifiers with Digital Player	43
PA Mixer Amplifiers with Digital Player	44

Intelligent Paging Systems

Intelligent Paging Systems	52
----------------------------------	----

Mixers & Processors

PA Mixers	56
DJ Mixer	62
PA Signal Processors	63
PA Effect Processors	64

Microphones

PA Microphones	66
Headband Microphones	72
PA Wireless Microphones	73
PA Gooseneck Microphones	80
PA Phantom Microphones	81
Paging Microphones	82
Special Purpose Microphone	82

Speakers

PA Driver Units / PA Horn Speakers	84
Low Impedance PA Horn Speakers	85
100V PA Horn Speakers	86
PA Music Horn Speaker	87
PA Horns / Diaphragms / PA Column Speakers	88
PA Ceiling Speakers	90
2-Way PA Ceiling Speakers	93
PA Wall Speakers	94
2-Way Compact PA Wall Speakers	95
PA Special Purpose Speakers	98

Speaker Volume Controllers	99
PA Cabinet Loudspeakers	100
PA Cabinet Loudspeaker - Stage Monitor	108
PA Active Loudspeaker - Stage Monitor	110
Moulded Cabinet PA Loudspeakers	111
PA Active Loudspeaker - Subwoofer	112
PA Cabinet Loudspeakers - Subwoofer	113
PA Line Array Loudspeakers	117
PA Speakers	120
PA Drivers	126
PA Horn Drivers	127
PA Piezo Horn Tweeters	127
PA Crossover Networks	128

Portable PA

PA Active Loudspeakers	132
Bi-Amp PA Active Loudspeakers	134
PA Amplifier Sets	136
2-Way Array Active Loudspeakers	140
PA Lectern	141
PA Megaphones	142

Counter Communication Systems

Counter Communication Systems	144
-------------------------------------	-----

PA Microphone and Speaker Stands

PA Microphone, Speaker Stands and Brackets	146
--	-----

PA Fundamentals

PA Fundamentals	147
-----------------------	-----

INDEX	149
-------------	-----

NEW

PA-200DS	37
PA-200S	37
FMX-106DP	61
FMX-106	61
DM-440	67
DM-740	67
MTP-20	82
CD-100	126
BTA-880	136
AM-24DP	142



Hallmark of Reliability!



Conference Systems

User friendly, feature laden & simple to install ! Attractive appearance & impeccable speech clarity!

The AHUJA conference systems provide an easy and much needed sound reinforcement solution for all meetings & conventions.

Applications

Auditoriums | Board Rooms | Seminar Halls | Conference Halls

Wireless Conference Systems

CWS-8000 Series



AHUJA Wireless Conference System features modern & robust design, intelligent control and accessibility. It uses a 2.4GHz digital communication technology with strong anti-interference features.

Secure and reliable wireless design for convenient installation. It features digital signal management and accurate information exchange. CWS-Series Wireless Conference System is ideal for various types of Corporate, Educational and Hotel Conference Rooms. The system can be installed with minimal wiring, thus not affecting the decor of the room.

- 2.4 GHz ADFHSS technology features high confidentiality and mitigates interference. The long operating range up to 40m can be increased using CSA-20.
- The conference system consists of one host unit, one chairman unit and multiple delegate units.
- Enables 4 transmitters to speak simultaneously without mutual interference.
- Optional FREE or REQUEST speech mode of delegate units controlled by the chairman unit.
- Intelligent power management system features battery power saving (All units turn off automatically when the host unit is turned off).
- Built-in high performance frequency shifter effectively reduces howling and enhances the sound pick up effect.
- All units have LCD display. Battery status is shown on the Chairman and Delegate Unit displays.
- Host unit features balanced and unbalanced audio output for convenient connection with audio amplifier.
- Use with separate Ahuja Amplifier and Speakers.

CWS-8300R HOST UNIT

- Operating Range upto 40 meters and can be increased using CSA-20.
- Frequency Response 70-15,000Hz.
- Power Supply: 12V DC from AC Adapter.
- Host unit should be used together CWS-8100C Chairman Unit, CWS-8200D Delegate Unit and GN -45 Gooseneck Microphone.



CWS-8100C CHAIRMAN UNIT

- FREE / REQUEST Mode Selection.
- Priority Function to override all Delegates units.
- LCD Displays the Working Status and battery charge.
- Microphone Indicator Ring LED.
- Features Anti-Interference Technology.
- Power Supply: 2 pcs., AA, Alkaline Batteries.
- Gooseneck Microphone 450mm (17³/₄") GN-45 to be purchased as a separate unit.



CWS-8200D DELEGATE UNIT

- Power/TALK Button.
- LCD Displays the Delegate Unit number.
- Microphone Indicator Ring LED.
- Features Anti-Interference Technology.
- Power Supply: 2 pcs., AA, Alkaline Batteries.
- Gooseneck Microphone 450mm (17³/₄") GN-45 to be purchased as a separate unit.



CSA-20 ANTENNA

Special high gain wall mounting antenna CSA-20 is supplied and sold separately. Mount it on a suitable microphone stand or hang it on a wall. The antenna should be at a suitable height, and facing the Chairman Unit/Delegate Units will help. This antenna is to be fixed to socket on the rear panel of the host unit in place of the standard antenna supplied.



GN-45 GOOSENECK MICROPHONE

Used with Chairman Unit CWS-8100C and Delegate Unit CWS-8200D.
Easy to connect.



SPECIFICATIONS

OPERATING RANGE	: 25-40m (Indoors)
FREQUENCY RESPONSE	: 70-15,000Hz
POWER SUPPLY	: Chairman & Delegate Unit : 2 × AA Alkaline batteries, Host Unit : DC: 12V / 1A AC adapter
DIMENSIONS	: Host Unit: W210 × H55 × D185 mm, Chairman Unit: W205 × H65 × D145 mm, Delegate Unit: W170 × H60 × D120 mm, Gooseneck Microphone Length: 450 mm, Antenna: W190 × H230 × D18 mm
WEIGHT	: Host Unit: 1.30kg, Chairman Unit: 830g, Delegate Unit: 560g, Gooseneck Microphone: 130g, Antenna: 380g



CM-5000 Series

50 WATTS ■ AC & 24V DC Operation

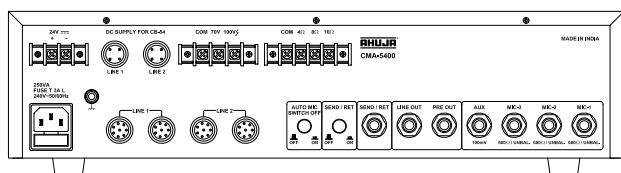

CMA-5400
CENTRAL MIXER AMPLIFIER



The new Ahuja Conference System CM-5000 facilitates smooth conduct of meetings by providing required level of intelligible sound reinforcement. The system is designed to handle a wide variety of conference applications in Boardrooms, Large Conference Halls as well as open conferencing in Convention Centres.

- Highly sensitive 470mm (18.5") long gooseneck microphone for comfortable sharing by two delegates.
- Bright and uniform band LED indicator.
- Chairman/Delegate Units have attractive and well contoured plastic top for superior appearance.
- Rugged and compact die cast metal base for better stability of Chairman/Delegate Units.
- Adjustable headphone output available from each Chairman/Delegate Unit.
- Automatic Mic Off feature in Delegate units which is selectable through a switch in the Central Mixer Amplifier.
- Chairman Unit has Priority Switch.
- Central Mixer Amplifier has a digital recorder for recording the proceedings. Also it can playback the pre-recorded messages.
- Switchable send/return facility in Central Mixer Amplifier.
- Three Mic inputs and one Aux input in Central Mixer Amplifier.
- 50W PA Amplifier for adequate sound reinforcement.
- Headphone output provided in Central Mixer Amplifier for monitoring purposes.
- AC Mains & 24V DC operation.
- Central Mixer Amplifier is 482.6 mm (19") rack mountable.
- Central Mixer Amplifier has the facility of feeding two independent groups of Delegate Units if required in large conference setups.
- Conference System can be installed in a bus bar arrangement by using Junction Boxes CB-45.



CMD-5200
DELEGATE UNIT

Each unit is provided with a 470mm (18.5") long gooseneck condenser microphone which is highly sensitive and unidirectional. The microphone is provided with a diffused LED housing to provide positive visual identification of the unit in operation. The built-in speaker in each unit provides clear and crisp sound reinforcement. The output level of the speaker can be adjusted through a recessed volume control in the unit. Each unit has a headphone output, TALK switch and a TALK LED. The MIC LEVEL LED in the delegate unit flickers to indicate microphone input signal level.



CMC-5100
CHAIRMAN UNIT

Apart from delegate unit functions, the chairman unit has a TALK switch with LED. It also has a PRIORITY switch with LED. When priority switch is pressed, a chime tone is generated to seek attention and mute the active delegate microphones.

SPECIFICATIONS	CMA-5400
Line Output 1	17.5V DC/3A Max.; -34dBV (20mV)
Line Output 2	17.5V DC/3A Max.; -34dBV (20mV)
Power Output	50W RMS at 2% THD, 90W Max.
Inputs	3×Mic 0.65mV/4.7kΩ 1×Aux 100mV/470kΩ
Frequency Response	60-14,000Hz (± 3dB)
S/N Ratio	> 60dB
Tone Controls	Bass: -10dB at 100Hz Treble: -10dB at 10kHz
Preamp Output	200mV/600Ω
Line Output	1V/1kΩ
Send Output	200mV/600Ω
Return Input	200mV/10kΩ
Speaker Output	4Ω, 8Ω, 16Ω, 70V & 100V
Power Requirement	AC: 220-240V, 50/60Hz DC: 24V (2×12V Car Battery)
Power Consumption	250VA
Protections	AC Fuse 1×3A, DC Fuse 3×10A
Dimensions	W483 × H110 × D325 mm
Weight	10.50kg
Accessories	1× Connection Cable CC-46 1× Extension Cable CC-47 1× Fuse 3A, 2 × Fuse 10A

SPECIFICATIONS	CMC-5100	CMD-5200
Microphone	-63dBV/μbar (7.5mV/Pa)	-63dBV/μbar (7.5mV/Pa)
Current Consumption	< 50mA Max.	< 50mA Max.
Mic Auto Switch-Off Time	—	75 seconds approx.
Input	Line	Line
Output	Line, Headphone	Line, Headphone
Speaker	Max Input 300mW	Max Input 300mW
Controls	Priority Switch, Talk Switch, Speaker Volume Control, Headphone Volume Control	Talk Switch, Speaker Volume Control, Headphone Volume Control
Dimensions	W118 × H70 × D160 mm	W118 × H70 × D160 mm
Weight	1.05 kg (w/o cable)	1.05 kg (w/o cable)
Accessories	Foam Windshield, 2.5m Interconnecting Cable	Foam Windshield, 2.5m Interconnecting Cable

SYSTEM CONFIGURATION

Central Mixer Amplifier	CMA-5400	1 Unit
Chairman Unit	CMC-5100	1 Unit
Delegate Unit	CMD-5200	N Units (N ≤ 50)



TYPICAL APPLICATIONS

Boardrooms

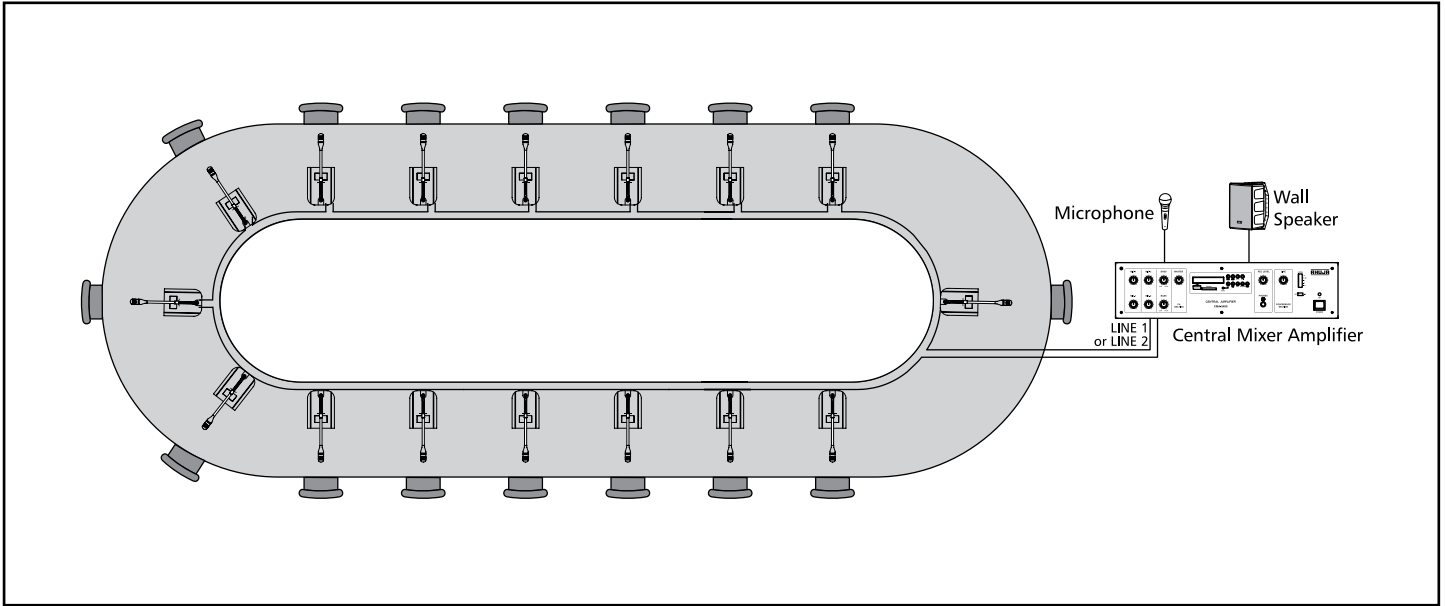

Convention Centres

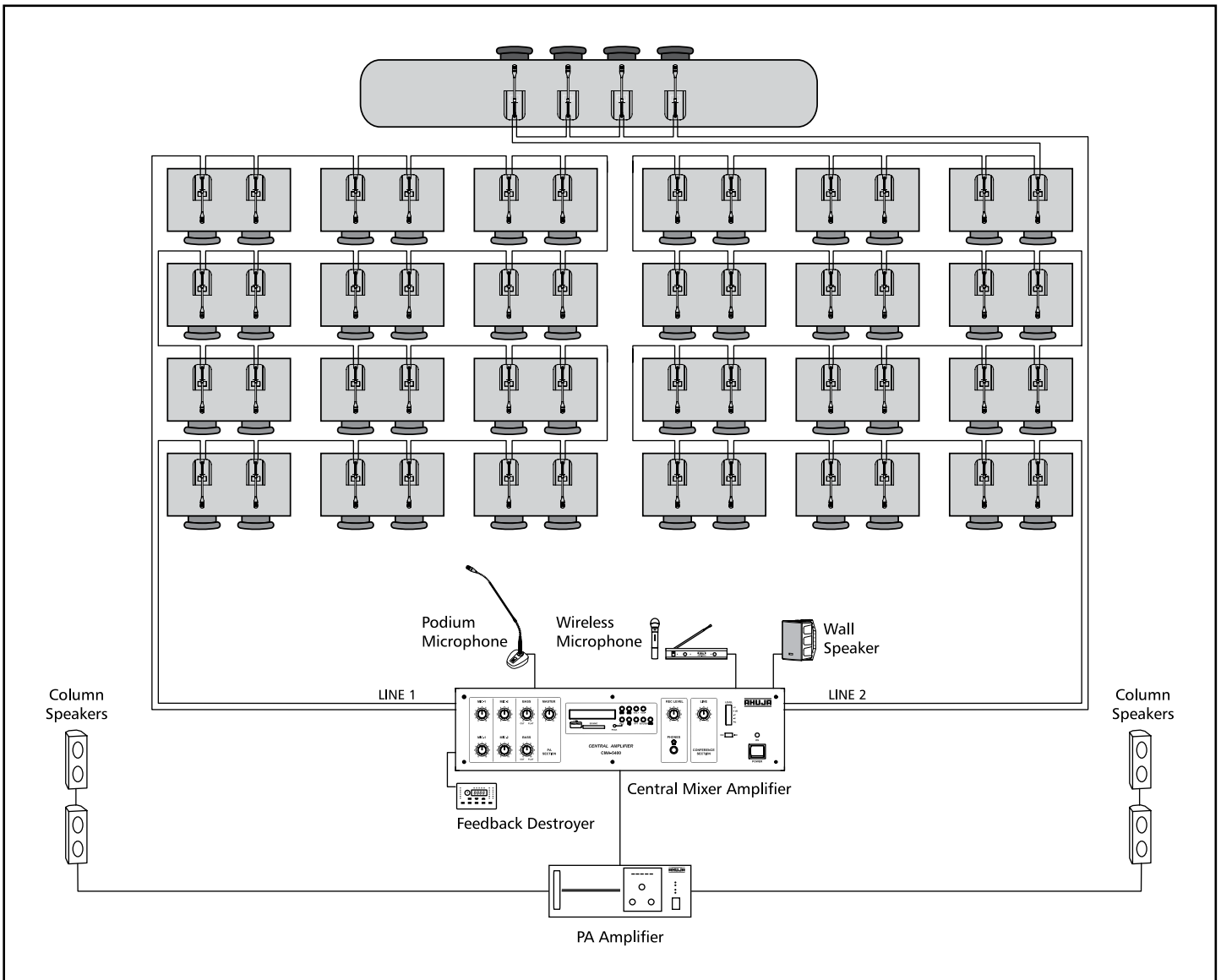

CM-4000 Series

50 WATTS ■ AC & 24V DC Operation

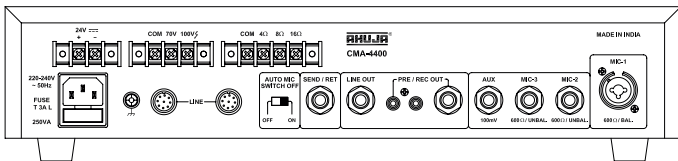

CMA-4400
CENTRAL MIXER AMPLIFIER



The Ahuja CM-4000 Conference System provides the much required sound reinforcement at meetings while eliminating problems of poor intelligibility and acoustic feedback. The system is ideal for use in a variety of applications in Boardrooms, Large Conference Halls as well as open conferencing in Convention Centres.

- Highly sensitive 400mm (16") long gooseneck microphone for comfortable sharing by two delegates.
- Bright and clear ring LED indicator.
- Compact and attractive die cast aluminium cabinet in a unique profile.
- Headphone output available from each unit.
- Automatic Mic Off feature in Delegate units.
- Unique Send/Return facility through a stereo jack in Central Mixer Amplifier CMA-4400.
- Chairman Unit has Priority Switch.
- Record & playback the messages with the Secretary Unit.
- AC Mains & 24V DC operation.
- Central Mixer Amplifier is 482.6 mm (19") rack mountable.
- Three Mic inputs and one Aux input for various user applications.
- 50W PA Amplifier for adequate sound reinforcement.
- System expansion possible through Conference Expansion Unit CMB-4500.
- Conference System can be installed in a bus bar arrangement by using Junction Boxes CB-45.

CMB-4500 CONFERENCE EXPANSION UNIT



An additional unit for adding more delegate units to the system. This unit also provides interconnection with the Central Mixer Amplifier CMA-4400. Works on 220-240V AC mains as well as 24V car battery.



CMC-4100
CHAIRMAN UNIT

The CMC-4100 Chairman and CMD-4200 Delegate Units have built-in loudspeakers and high quality sensitive electret condenser transducer mounted on 400mm (16") flexible goosenecks. The microphones of the units are equipped with a Ring LED indicator for easy visual identification of the unit in operation. Each unit has a headphone output with volume control.



CMD-4200
DELEGATE UNIT

The stylish, free-standing cast aluminium case has an angled fascia incorporating the TALK switch which automatically mutes the internal speaker.

The Chairman Unit also has a non-lockable PRIORITY switch which interrupts the meeting with a chime tone and mutes the delegates' microphones. Both units have recessed volume controls for setting desired sound levels.



CMS-4300
SECRETARY UNIT

The matching CMS-4300 Secretary Unit has a built-in loudspeaker and a headphone output with volume control. The Secretary Unit enables proceedings to be recorded through a cassette recorder, for a stenographer present to take notes and to relay pre-recorded messages or music to delegates.

SPECIFICATIONS	CMA-4400	SPECIFICATIONS	CMC-4100	CMD-4200	CMS-4300
Line Output	17.5V DC/3A Max.; -34dBV (20mV)	Microphone	-63dBV/μbar (7.5mV/Pa)	-63dBV/μbar (7.5mV/Pa)	—
Power Output	50W RMS at 2% THD, 90W Max.	Current Consumption	< 50mA Max.	< 50mA Max.	< 50mA Max.
Inputs	1×Mic 1.0mV/2kΩ (Balanced) 2×Mic 0.65mV/4.7kΩ (Unbalanced) 1×Aux 100mV/470kΩ (Unbalanced)	Mic Auto Switch-Off Time	—	75 seconds approx.	—
Frequency Response	60-14,000Hz (± 3dB)	Input	Line	Line	Line, Playback
S/N Ratio	> 60dB	Output	Line, Headphone	Line, Headphone	Line, Record, Headphone
Tone Controls	Bass: -10dB at 100Hz Treble: -10dB at 10kHz	Speaker	Max Input 300mW Impedance 16Ω	Max Input 300mW Impedance 16Ω	Max Input 300mW Impedance 16Ω
Preamp / Rec Output	200mV/600Ω	Controls	Priority Switch, Talk Switch, Speaker	Talk Switch, Speaker Volume Control,	Monitor Speaker Volume Control,
Line Output	1V/1kΩ		Volume Control,	Headphone	Headphone
Send Output	200mV/600Ω		Headphone Volume	Volume Control	Volume Control
Return Input	200mV/10kΩ		Control		
Speaker Output	4Ω, 8Ω, 16Ω, 70V & 100V	Dimensions (in mm)	W145×H75×D180	W145×H75×D180	W145×H75×D180
Power Requirement	AC: 220-240V, 50/60Hz DC: 24V (2×12V Car Battery)	Weight	1.30kg (w/o cable)	1.30kg (w/o cable)	1.15kg (w/o cable)
Power Consumption	250VA	Accessories	Foam Windshield, 2.5m Interconnecting Cable	Foam Windshield, 2.5m Interconnecting Cable	4 Pin Plug for REC/PB, 2.5m Interconnecting Cable
Protections	AC Fuse 1×3A, DC Fuse 2×10A				
Dimensions	W482 × H88 × D295 mm				
Weight	8.70kg				
Accessories	1× Connection Cable CC-46 1× Extension Cable CC-47 1× Fuse 3A 1× Fuse 10A				

SYSTEM CONFIGURATION			
Chairman Unit	CMC-4100 1 Unit	Secretary Unit	CMS-4300 1 Unit
Delegate Unit	CMD-4200 N Units (N ≤ 50)	Central Mixer Amplifier	CMA-4400 1 Unit



Hallmark of Reliability!



Amplifiers

World renowned, time-tested, rugged and reliable amplifiers.

Sterling quality without compromise!

Passed down from generation to generation... users & installers alike testify to the reliability of AHUJA amplifiers!

Applications

Airports | Conventions | DJs | Stadiums | Electioneering | Fairs & Exhibitions

Defence Installations | Bus Terminals | Announcements & Music | Mobile PA

Schools & Colleges | Coaching Centers | Places of Worship

Dual Channel Power Amplifiers

LXA-7600

3800+3800 WATTS ■ AC Operation

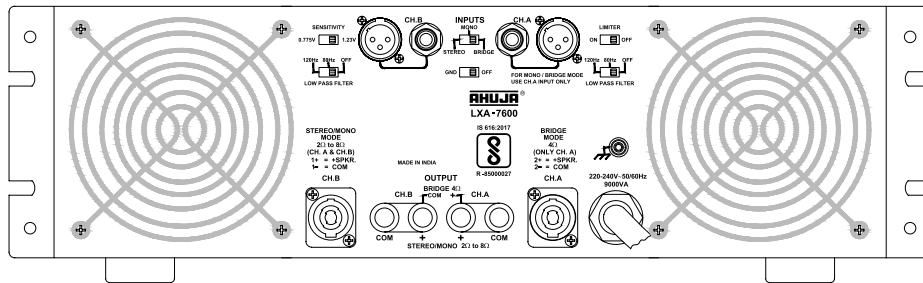

- Dual channel direct coupled power amplifier.
- 7600 Watts rated output.
- Rugged and most reliable. A new benchmark for professionals requiring a sonically superior high power amplifier.
- 80Hz / 120Hz LPF.
- Built-in circuit for HF protection.
- Limiter ON/OFF.
- Two selectable input sensitivities.
- Class H operation for optimum efficiency.
- BIS approved.

SPECIFICATIONS

LXA-7600

CONTINUOUS RATED POWER	
STEREO/MONO	8Ω : 1600W + 1600W RMS, 4Ω : 2600W + 2600W RMS 2Ω : 3800W + 3800W RMS
BRIDGED OUTPUT	8Ω : 5200W RMS, 4Ω : 7600W RMS
THD + N	< 1.0%
FREQUENCY RESPONSE (-1dB)	20-20,000Hz
LOW PASS FILTER	80/120Hz @ 24dB per octave
POWER BANDWIDTH (0.5% THD)	20-20,000Hz
INPUT SENSITIVITY	0dBu (775mV) & 4dBu (1.23V) (Selectable)
INPUT IMPEDANCE	10k Unbalanced, 20k Balanced
SIGNAL TO NOISE RATIO	> 95dB
CHANNEL SEPARATION	> 65dB at 1kHz
DAMPING FACTOR	400 : 1 (8Ω)
SLEW RATE	35V/μS
PROTECTIONS	Temperature, DC, RFI, Short Circuit, Overload, Built-in Limiter (ON/OFF) AC: Magnetic Circuit Protector 20A; ± DC: Fuse 1 X 30A (T 30A L) for each Channel, Fuse 2×3 A (T 3A L)
INPUT CONNECTORS	2×XLR, Stereo Phone Jack 6.3mm
OUTPUT CONNECTORS	Speakon 4-Way and heavy duty Binding Post for each channel
COOLING	2×Fixed Speed DC Fan and 2 × Variable Speed DC Fan with Temperature Sensing
FRONT PANEL CONTROLS	2×41 Step Level Attenuators
INDICATORS	Power ON, Signal, Clip, Temperature, Protect (Ch. A & B)
POWER CONSUMPTION (RATED)	9000VA @ 220-240V ~ 50/60Hz
DIMENSIONS	W482 × H153 × D605mm
WEIGHT	39.50kg

Dual Channel Power Amplifiers

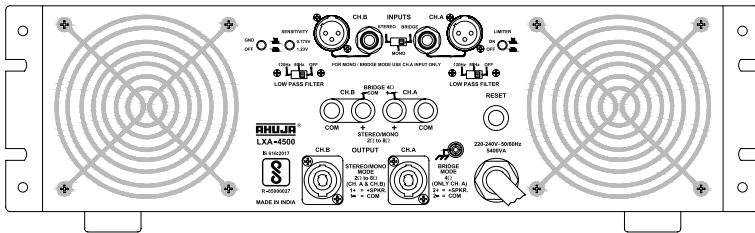
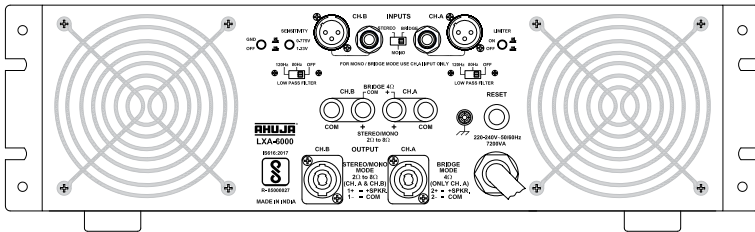

LXA-6000

3000+3000 WATTS ■ AC Operation

- Dual channel direct coupled power amplifier.
- 6000 Watts rated output.
- Rugged and most reliable. A new benchmark for professionals requiring a sonically superior high power amplifier.
- 80Hz / 120Hz LPF.
- Built-in circuit for HF protection.
- Limiter ON/OFF.
- Two selectable input sensitivities.
- Class H operation for optimum efficiency.
- BIS approved.

LXA-4500

2250+2250 WATTS ■ AC Operation

- Dual channel direct coupled power amplifier.
- 4500 Watts rated output.
- Rugged and most reliable. A new benchmark for professionals requiring a sonically superior high power amplifier.
- 80Hz / 120Hz LPF.
- Built-in circuit for HF protection.
- Limiter ON/OFF.
- Two selectable input sensitivities.
- Class H operation for optimum efficiency.
- BIS approved.

SPECIFICATIONS

LXA-6000

LXA-4500

	LXA-6000	LXA-4500
CONTINUOUS RATED POWER		
STEREO/MONO	8Ω : 1300W + 1300W RMS, 4Ω : 2000W + 2000W RMS 2Ω : 3000W + 3000W RMS	8Ω : 1000W + 1000W RMS, 4Ω : 1550W + 1550W RMS 2Ω : 2250W + 2250W RMS
BRIDGED OUTPUT	8Ω : 4000W RMS, 4Ω : 6000W RMS	8Ω : 3100W RMS, 4Ω : 4500W RMS
THD + N	< 1.0%	< 1.0%
FREQUENCY RESPONSE (-1dB)	20-20,000Hz	20-20,000Hz
LOW PASS FILTER	80/120Hz @ 24dB per octave	80/120Hz @ 24dB per octave
POWER BANDWIDTH (0.5% THD)	20-20,000Hz	20-20,000Hz
INPUT SENSITIVITY	0dBu (775mV) & 4dBu (1.23V) (Selectable)	0dBu (775mV) & 4dBu (1.23V) (Selectable)
INPUT IMPEDANCE	10k Unbalanced, 20k Balanced	10k Unbalanced, 20k Balanced
SIGNAL TO NOISE RATIO	> 95dB	> 95dB
CHANNEL SEPARATION	> 65dB at 1kHz	> 65dB at 1kHz
DAMPING FACTOR	400 : 1 (8Ω)	400 : 1 (8Ω)
SLEW RATE	35V/μS	35V/μS
PROTECTIONS	Temperature, DC, RFI, Short Circuit, Overload, Built-in Limiter (ON/OFF) AC: Circuit Protector 25A; ± DC: Fuse 2 X 30A (T 30A L) for each channel, Fuse 2 X 3 A (T 3A L)	Temperature, DC, RFI, Short Circuit, Overload, Built-in Limiter (ON/OFF) AC: Circuit Protector 20A; ± DC: Fuse 2 X 25A (T 25A L) for each channel, Fuse 2 X 3 A (T 3A L)
INPUT CONNECTORS	2 X XLR, Stereo Phone Jack 6.3mm	2 X XLR, Stereo Phone Jack 6.3mm
OUTPUT CONNECTORS	Speakon 4-Way and heavy duty Binding Post for each channel	Speakon 4-Way and heavy duty Binding Post for each channel
COOLING	Variable Speed DC Fan with Temperature Sensing	Variable Speed DC Fan with Temperature Sensing
FRONT PANEL CONTROLS	2 X 41 Step Level Attenuators	2 X 41 Step Level Attenuators
INDICATORS	Power ON, Signal, Clip, Temperature, Protect (Ch. A & B)	Power ON, Signal, Clip, Temperature, Protect (Ch. A & B)
POWER CONSUMPTION (RATED)	7200VA @ 220-240V ~ 50/60Hz	5400VA @ 220-240V ~ 50/60Hz
DIMENSIONS	W482 X H153 X D605mm	W482 X H153 X D580mm
WEIGHT	39.00kg	36.50kg

Dual Channel Power Amplifiers

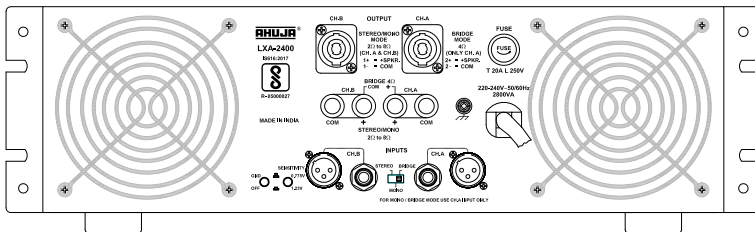
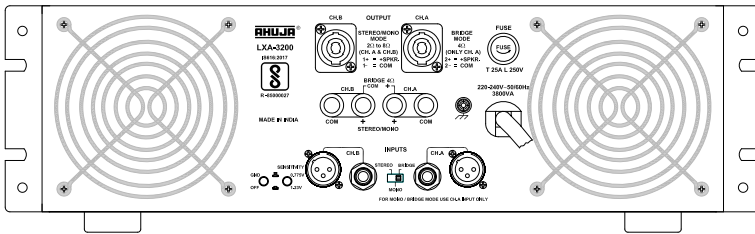

LXA-3200

1600+1600 WATTS ■ AC Operation

- Dual channel direct coupled power amplifier.
- 3200 Watts rated output.
- Rugged, reliable and designed to work continuously under stringent conditions
- High fidelity sound.
- Ideal for high end music programmes.
- Two selectable input sensitivities.
- Class H operation for optimum efficiency.
- BIS approved.

LXA-2400

1200+1200 WATTS ■ AC Operation

- Dual channel direct coupled power amplifier.
- 2400 Watts rated output.
- Rugged and most reliable. A new benchmark for professionals requiring a sonically superior high power amplifier.
- Two selectable input sensitivities.
- Class H operation for optimum efficiency.
- BIS approved.

SPECIFICATIONS

	LXA-3200	LXA-2400
CONTINUOUS RATED POWER		
STEREO/MONO	8Ω : 700W + 700W RMS, 4Ω : 1100W + 1100W RMS 2Ω : 1600W + 1600W RMS	8Ω : 600W + 600W RMS, 4Ω : 850W + 850W RMS 2Ω : 1200W + 1200W RMS
BRIDGED OUTPUT	8Ω : 2200W RMS, 4Ω : 3200W RMS	8Ω : 1700W RMS, 4Ω : 2400W RMS
THD + N	< 1.0%	< 1.0%
FREQUENCY RESPONSE (-1dB)	20-20,000Hz	20-20,000Hz
POWER BANDWIDTH (0.5% THD)	20-20,000Hz	20-20,000Hz
INPUT SENSITIVITY	0dBu (775mV) & 4dBu (1.23V) (Selectable)	0dBu (775mV) & 4dBu (1.23V) (Selectable)
INPUT IMPEDANCE	10k Unbalanced, 20k Balanced	10k Unbalanced, 20k Balanced
SIGNAL TO NOISE RATIO	> 95dB	> 95dB
CHANNEL SEPARATION	> 65dB at 1kHz	> 65dB at 1kHz
DAMPING FACTOR	400 : 1 (8Ω)	400 : 1 (8Ω)
SLEW RATE	35V/μS	35V/μS
PROTECTIONS	Temperature, DC, RFI, Short Circuit, Overload, Built-in Limiter AC: Fuse 25Amp. (T 25A L); ± DC: Fuse 2 X 25A (T 25A L) for each channel, Fuse 2×3 A (T 3A L)	Temperature, DC, RFI, Short Circuit, Overload, Built-in Limiter AC: Fuse 20A (T 20A L); ± DC: Fuse 2 X 20A (T 20A L) for each channel, Fuse 2×3A (T 3A L)
INPUT CONNECTORS	2× XLR, Stereo Phone Jack 6.3mm	2×XLR, Stereo Phone Jack 6.3mm
OUTPUT CONNECTORS	Speakon 4-Way and heavy duty Binding Post for each channel	Speakon 4-Way and heavy duty of Binding Post for each channel
COOLING	Variable Speed DC Fan with Temperature Sensing	Variable Speed DC Fan with Temperature Sensing
FRONT PANEL CONTROLS	2×41 Step Level Attenuators	2×41 step level Attenuators
INDICATORS	Power ON, Signal, Clip, Temperature, Protect (Ch. A & B)	Power ON, Signal, Clip, Temperature, Protect (Ch. A & B)
POWER CONSUMPTION (RATED)	3800VA @ 220-240V ~ 50/60Hz	2800VA @ 220-240V ~ 50/60Hz
DIMENSIONS	W482 × H153 × D550mm	W482 × H153 × D550mm
WEIGHT	33.00kg	28.70kg

Dual Channel Power Amplifiers

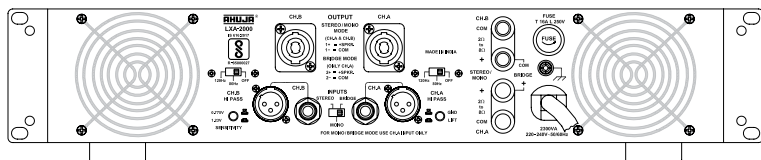

LXA-2000

1000+1000 WATTS ■ AC Operation

- Dual channel direct coupled power amplifier.
- 2000 Watts rated output.
- Rugged and most reliable. A new benchmark for professionals requiring a sonically superior high power amplifier.
- Selectable HPF (120Hz / 80Hz / OFF)
- Two selectable input sensitivities.
- Class H operation for optimum efficiency.
- BIS approved.

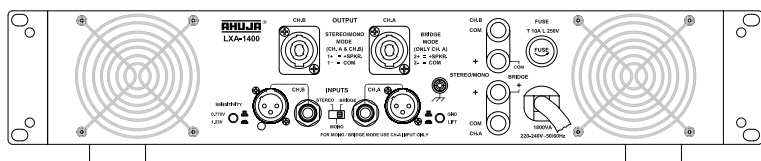

LXA-1400

675+675 WATTS ■ AC Operation

- Dual channel direct coupled power amplifier.
- 1350 Watts rated output.
- Rugged, reliable and designed to work continuously under stringent conditions
- High fidelity sound.
- Two selectable input sensitivities.
- Ideal for high end music programmes.

SPECIFICATIONS	LXA-2000	LXA-1400
CONTINUOUS RATED POWER		
STEREO/MONO	8Ω: 400W + 400W RMS, 4Ω: 700W + 700W RMS 2Ω: 1000W + 1000W RMS	8Ω: 250W + 250W RMS, 4Ω: 475W + 475W RMS 2Ω: 675W + 675W RMS
BRIDGED OUTPUT	8Ω: 1400W RMS, 4Ω: 2000W RMS	8Ω: 950W RMS, 4Ω: 1350W RMS
THD + N	< 1.0%	< 1.0%
FREQUENCY RESPONSE (-1dB)	20-20,000Hz	20-20,000Hz
POWER BANDWIDTH (0.5% THD)	20-20,000Hz	20-20,000Hz
HIGH PASS FILTER	80/120Hz @ 12dB per octave	—
INPUT SENSITIVITY	0dBu (775mV) & 4dBu (1.23V) (Selectable)	0dBu (775mV) & 4dBu (1.23V) (Selectable)
INPUT IMPEDANCE	10k Unbalanced, 20k Balanced	10k Unbalanced, 20k Balanced
SIGNAL TO NOISE RATIO	> 95dB	> 95dB
CHANNEL SEPARATION	> 65dB at 1kHz	> 65dB at 1kHz
DAMPING FACTOR	400 : 1 (8Ω)	400 : 1 (8Ω)
SLEW RATE	35V/μS	35V/μS
PROTECTIONS	Temperature, DC, RFI, Short Circuit, Overload, Built-in Limiter AC: Fuse 16A (T 16A L); ± DC: Fuse 2 × 16A (T 16A L) for each channel, ± DC: Fuse 2 × 2A (T 2A L) (for Fan Supply)	Temperature, DC, RFI, Short Circuit, Overload, Built-in Limiter, AC: Fuse 10A (T 10A L); ± DC: Fuse 2 × 10A (T 10A L) for each channel, ± DC: Fuse 2 × 2A (T 2A L) (for Fan Supply)
INPUT CONNECTORS	2 × XLR, Stereo Phone Jack 6.3mm	2 × XLR, Stereo Phone Jack 6.3mm
OUTPUT CONNECTORS	Speakon 4-Way and Heavy duty Binding Post for each channel	Speakon 4-Way and Heavy duty Binding Post for each channel
COOLING	Variable Speed DC Fan with Temperature Sensing	Variable Speed DC Fan with Temperature Sensing
FRONT PANEL CONTROLS	2 × 41 Step Level Attenuators	2 × 21 Step Level Attenuators
INDICATORS	Power ON, Signal, Clip, Temperature, Protect (Ch. A & B)	Power ON, Signal, Clip, Temperature, Protect (Ch. A & B)
POWER CONSUMPTION (RATED)	2300VA @ 220-240V ~ 50/60Hz	1800VA @ 220-240V ~ 50/60Hz
DIMENSIONS	W482 × H113 × D530mm	W482 × H113 × D460 mm
WEIGHT	21.90kg	14.70kg

Dual Channel Power Amplifiers

DXA-3502

1750+1750 WATTS ■ AC Operation

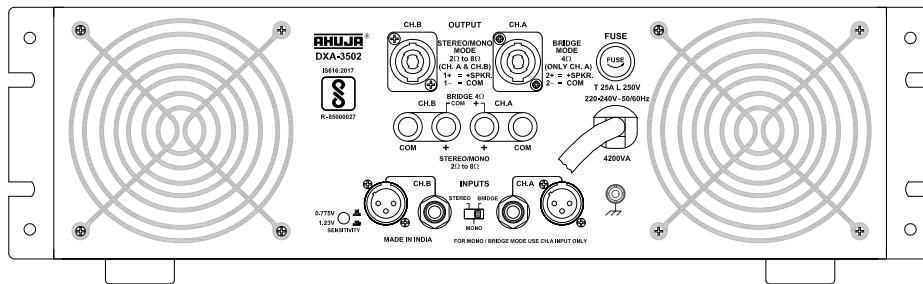

DXA-3502 is a rugged and most reliable dual channel power amplifier. It sets a new benchmark for professionals requiring a sonically superior, high power amplifier. It has been designed to operate under stringent working conditions such as wide voltage fluctuations due to DG Set/AC mains and high ambient temperatures. Adequate safeguards have been built-in to counter adverse working conditions. Ease of operation, combined with service accessibility has been optimized in the design. Class H operation for optimum efficiency. BIS approved.

SPECIFICATIONS	DXA-3502
CONTINUOUS RATED POWER	
STEREO/MONO	8Ω : 700W + 700W RMS, 4Ω : 1200W + 1200W RMS 2Ω : 1750W + 1750W RMS
BRIDGED OUTPUT	8Ω : 2400W RMS, 4Ω : 3500W RMS
SINGLE CHANNEL DRIVEN OUTPUT	8Ω : 750W RMS, 4Ω : 1350W RMS, 2Ω : 1900W RMS
THD + N	0.5%
FREQUENCY RESPONSE (-1dB)	20-20,000Hz
POWER BANDWIDTH (0.5% THD)	20-20,000Hz
INPUT SENSITIVITY	0dBu (775mV) & 4dBu (1.23V) (Selectable)
INPUT IMPEDANCE	10k Unbalanced , 20k Balanced
SIGNAL TO NOISE RATIO	95dB
CHANNEL SEPARATION	65dB at 1kHz
DAMPING FACTOR	400 : 1 (8Ω)
SLEW RATE	35V/μs
PROTECTIONS	Temperature, DC, RFI, Short Circuit, Overload, AC over voltage, Built-in limiter AC: Fuse 25A (T 25A L), ± DC: Fuse 2×25A (T 25A L) each channel & Fuses 2×3A (T 3A L)
INPUT CONNECTORS	2×XLR, Stereo Phone Jack 6.3mm
OUTPUT CONNECTORS	Speakon 4-Way and Heavy Duty Binding Post for each channel
COOLING	Variable Speed DC Fan with Temperature Sensing
FRONT PANEL CONTROLS	2×41 Step Level Attenuators
INDICATORS	ON, Signal, Clip, Temperature, Protect (Ch. A & B)
POWER CONSUMPTION	4200VA @ 220-240V ~ 50/60Hz
DIMENSIONS	W482 × H153 × D580mm
WEIGHT	37.50kg

Two Zone PA Power Amplifiers

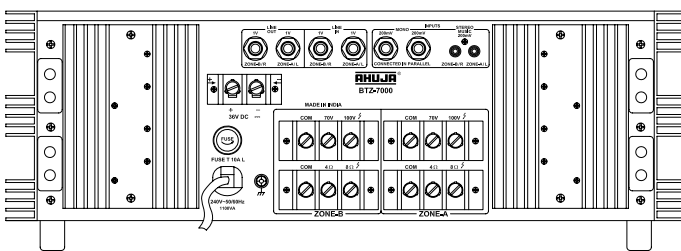
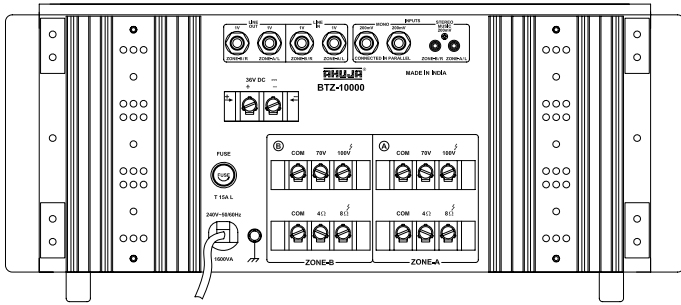

BTZ-10000

1000 WATTS ■ AC & 36V DC Operation

- Stereo Music input for DJ programmes.
- Facilitates connection and operation of two groups of speakers simultaneously on 'Mono' mode. Ideal for Places of Worship.
- Line Input & Output on each zone for connecting to a PA Mixer and a Booster Amplifier respectively.
- Box Speaker/Driver Unit selector switch for each zone. Bass boost defeated at Driver Unit position for safer operation of driver units.
- Resettable circuit breaker for protection against overload and short circuit.
- Zone On/Off facility. Output levels of each Zone can be set independently to desired levels and the zones can be switched On/Off without disturbing the volume settings.
- Instant transfer to DC power (Car Battery) if AC power fails.
- Bar Graph Signal Display.

BTZ-7000

700 WATTS ■ AC & 36V DC Operation

- Stereo Music Operation for DJ programmes.
- Facilitates connection and operation of two separate groups of speakers simultaneously on 'Mono' mode. Ideal for places of worship.
- Box Speaker/Driver Unit selector switch for each zone. Bass boost defeated at Driver Unit position for safer operation of driver units.
- Resettable circuit breaker for protection against overload and short circuit.
- Zone On/Off facility. Output levels of each Zone can be set independently to desired levels and the zones can be switched On/Off without disturbing the volume settings.
- Instant transfer to DC power (Car Battery) if AC power fails.
- Bar Graph Signal Display.

SPECIFICATIONS

	BTZ-10000	BTZ-7000
POWER OUTPUT	750W + 750W Max., 500W + 500W RMS at 10% THD 450W + 450W RMS at 5% THD, 415W + 415W RMS at 2% THD	500W + 500W Max., 350W + 350W RMS at 10% THD 300W + 300W RMS at 5% THD, 280W + 280W RMS at 2% THD
OUTPUT REGULATION	≤ 2 dB, no load to full load at 1kHz	≤ 2 dB, no load to full load at 1kHz
INPUT CHANNELS	Mono 2 × 200mV/100kΩ Stereo L/R 200mV/100kΩ, Line L/R 1V/50kΩ	Mono 2 × 200mV/100kΩ Stereo L/R 200mV/100kΩ, Line L/R 1V/50kΩ
FREQUENCY RESPONSE	50-15,000Hz ±3dB	50-15,000Hz ±3dB
SIGNAL TO NOISE RATIO	60dB	60dB
TONE CONTROLS	Bass: ±10dB at 100Hz, Treble: ±10dB at 10kHz	Bass: ±10dB at 100Hz, Treble: ±10dB at 10kHz
OUTPUTS	Line 1V/1kΩ	Line L/R 1V/1kΩ
SPEAKER OUTPUTS	4Ω, 8Ω, 70V & 100V for each zone	4Ω, 8Ω, 70V & 100V for each zone
POWER SUPPLY	AC: 220-240V 50/60Hz DC: 36V (3 × 12V Car Battery)	AC: 220-240V 50/60Hz DC: 36V (3 × 12V Car Battery)
POWER CONSUMPTION	AC: 1600VA DC: 16A	AC: 1100VA DC: 13A
DIMENSIONS	W510 × H220 × D440 mm	W510 × H185 × D470 mm
WEIGHT	40.00kg	39.00kg



Two Zone PA Mixer Amplifiers

TZA-7000®

700 WATTS ■ AC & 36V DC Operation

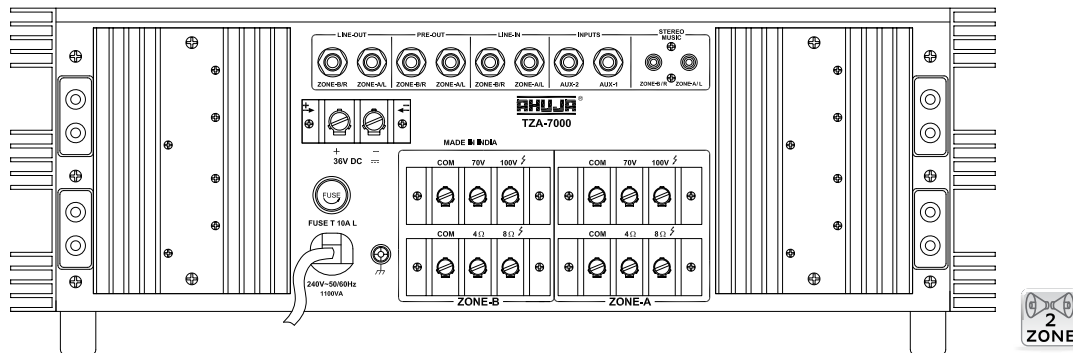

Ahuja model TZA-7000 is rugged, reliable, cost-effective 700 watts Two Zone PA Mixer Amplifier. TZA-7000 is ideal for multi-speaker installations where a user needs to separately set power levels for two separate areas such as indoors & outdoors.

- 6 Mic & 2 Aux Inputs.
- Stereo Music Operation for DJ programmes.
- Facilitates connection and operation of two separate groups of speakers simultaneously on 'Mono' mode. Ideal for Places of Worship.
- Line Input & Output on each zone for connecting to a PA Mixer and a Booster Amplifier respectively. Preamp output for recording.
- Box Speaker/Driver Unit selector switch for each zone. Bass boost defeated at Driver Unit position for safer operation of driver units. Zone On/Off facility.
- Resettable circuit breaker for protection against overload and short circuit.
- Instant transfer to DC power (Car Battery) if AC power fails.
- Bar Graph Signal Display.

SPECIFICATIONS

TZA-7000®

POWER OUTPUT	500W + 500W Max., 350W + 350W RMS at 10% THD 300W + 300W RMS at 5% THD, 280W + 280W RMS at 2% THD
OUTPUT REGULATION	≤ 2 dB, no load to full load at 1kHz
INPUT CHANNELS	Mono 6 × Mic 0.6mV/4.7kΩ, 2 × Aux 100mV/470kΩ Stereo L/R 200mV/100kΩ, Line L/R 1V/50kΩ
FREQUENCY RESPONSE	50-15,000Hz ±3dB
SIGNAL TO NOISE RATIO	60dB
TONE CONTROLS	Bass: ±10dB at 100Hz, Treble: ±10dB at 10kHz
OUTPUTS	Preamp 200mV/600Ω, Line 1V/1kΩ
SPEAKER OUTPUTS	4Ω, 8Ω, 70V & 100V for each zone
POWER SUPPLY	AC: 220-240V 50/60Hz DC: 36V (3 × 12V Car Battery)
POWER CONSUMPTION	AC: 1100VA DC: 13A
DIMENSIONS	W510 × H185 × D470 mm
WEIGHT	39.80kg

Two Zone PA Mixer Amplifiers

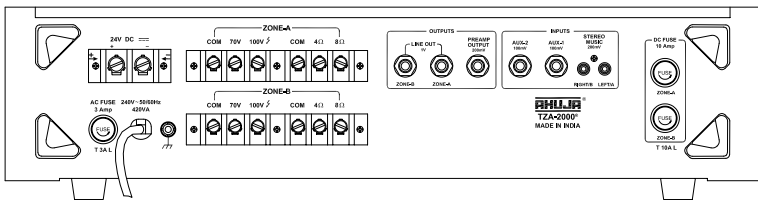
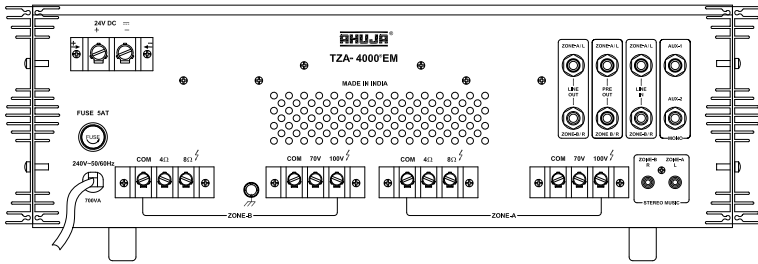

TZA-4000®EM

400 WATTS ■ AC & 24V DC Operation

- 6 Mic & 2 Aux Inputs.
- Stereo Music Operation for DJ programmes.
- Facilitates connection and operation of two separate groups of speakers simultaneously on Mono mode. Ideal for Places of Worship.
- Line Input & Output on each zone for connecting to a PA Mixer and a Booster Amplifier respectively. Preamp output for recording.
- Box Speaker/Driver Unit selector switch for each zone. Bass boost defeated at Driver Unit position for safer operation of driver units. Zone On/Off facility.
- Resettable circuit breaker for protection against overload and short circuit.
- Instant transfer to DC power (Car Battery) if AC power fails.

TZA-2000®

200 WATTS ■ AC & 24V DC Operation

- 6 Mic & 2 Aux Inputs.
- 100W+100W power output whereas it is 200W+200W in TZA-4000EM.
- Features are similar to TZA-4000EM. 'Stereo' music operation, connecting of two separate groups of speakers, line inputs & outputs, preamp outputs, zone On/Off facility, DC fuses at rear panel, AC/DC operation have been provided.
- While TZA-4000EM is suitable for large installations, TZA-2000 is ideal for medium sized installations such as in places of worship where two separate groups of speakers are needed to be connected.
- User has a choice to connect both the zones to 100V (LMT) type speakers, or 100V speakers to one zone and low impedance type speakers to the other zone. Both the zones can also be connected to low impedance type speakers.
- Instant transfer to DC power (Car Battery) if AC power fails.

Ahuja models TZA-4000®EM and TZA-2000® are rugged, reliable, cost-effective 400 watts & 200 watts Two Zone PA Mixer Amplifiers. These are ideal for multi-speaker installations where a user needs to separately set power levels for two separate areas such as indoors & outdoors.

SPECIFICATIONS	TZA-4000®EM	TZA-2000®
POWER OUTPUT	300W + 300W Max., 200W + 200W RMS at 10% THD 180W + 180W RMS at 5% THD, 165W + 165W RMS at 2% THD	130W + 130W Max., 100W + 100W RMS at 10% THD 90W + 90W RMS at 5% THD, 80W + 80W RMS at 2% THD
OUTPUT REGULATION	≤ 2 dB, no load to full load at 1kHz	≤ 2 dB, no load to full load at 1kHz
INPUT CHANNELS	Mono 6 × Mic 0.6mV/4.7kΩ, 2 × Aux 100mV/470kΩ Stereo L/R 200mV/100kΩ, Line L/R 1V/50kΩ	Mono 6 × Mic 0.6mV/4.7kΩ, 2 × Aux 100mV/470kΩ Stereo L/R 250mV/47kΩ
FREQUENCY RESPONSE	50-15,000Hz ±3dB	50-15,000Hz ±3dB
SIGNAL TO NOISE RATIO	60dB	60dB
TONE CONTROLS	Bass: ±10dB at 100Hz, Treble: ±10dB at 10kHz	Bass: ±10dB at 100Hz, Treble: ±10dB at 10kHz
OUTPUTS	Preamp 200mV/600Ω, Line 1V/1kΩ	Preamp 200mV/600Ω, Line 1V/1kΩ
SPEAKER OUTPUTS	4Ω, 8Ω, 70V & 100V for each zone	4Ω, 8Ω, 70V & 100V for each zone
POWER SUPPLY	AC: 220-240V 50/60Hz DC: 24V (2×12V Car Battery)	AC: 220-240V 50/60Hz DC: 24V (2×12V Car Battery)
POWER CONSUMPTION	AC: 700VA DC: 9A	AC: 420VA DC: 6.5A
DIMENSIONS	W510 × H172 × D385 mm	W500 × H140 × D340 mm
WEIGHT	24.20kg	17.40kg



Two Zone PA Mixer Amplifiers

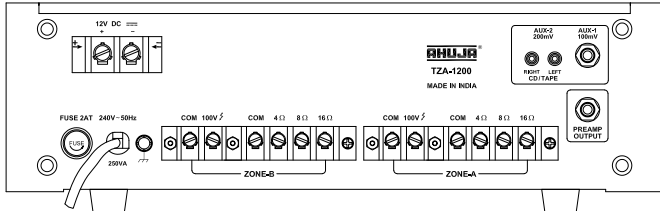
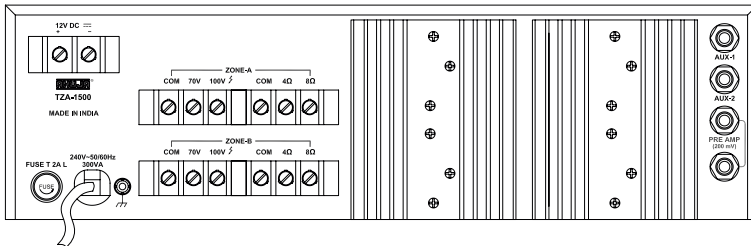

TZA-1500

160 WATTS ■ AC & 12V DC Operation

- 6 Mic & 2 Aux Inputs.
- Pre-amplifier output for connecting to a Booster Amplifier and for recording the programme.
- Bass & Treble Controls.
- TZA-1500 permits connecting 100V (LMT) type speakers to one Zone and low impedance type speakers to other Zone without causing overloading and over heating.
- Instant transfer to DC power (Car Battery) if AC power fails.
- Zone On/Off facility. Output levels of each Zone can be set independently to desired levels and the zones can be switched On/Off without disturbing the volume settings.

TZA-1200

120 WATTS ■ AC & 12V DC Operation

- 5 Mic & 2 Aux Inputs.
- 60W+60W power output whereas it is 80W+80W in TZA-1500.
- Features are similar to TZA-1500. Connecting two groups of speakers, pre-amplifier output, bass and treble controls, zone On/Off facility, AC/DC operation have been provided.
- TZA-1200 is suitable for small sized installations such as in places of worship where both external and internal speakers are required to be connected with different sound level settings whereas TZA-1500 is suitable for medium size installations and for mobile orchestras.
- Instant transfer to DC power (Car Battery) if AC power fails.

Ahuja models TZA-1500 and TZA-1200 are cost-effective 160 watts & 120 watts Two Zone PA PA Mixer Amplifiers. These are designed to give medium power clean sound and reliable, trouble free operation under extreme climatic conditions. Ideal for use in small and medium sized installations such as in Schools, Banquet Halls, Places of Worship etc., where separate sets of speakers for indoors & outdoors are needed.

SPECIFICATIONS	TZA-1500	TZA-1200
POWER OUTPUT	100W + 100W Max., 80W + 80W RMS at 10% THD 70W + 70W RMS at 5% THD, 60W + 60W RMS at 2% THD	90W + 90W Max., 60W + 60W RMS at 10% THD 55W + 55W RMS at 5% THD, 50W + 50W RMS at 2% THD
OUTPUT REGULATION	≤ 2 dB, no load to full load at 1kHz	≤ 2 dB, no load to full load at 1kHz
INPUT CHANNELS	6 × Mic 0.6mV/4.7kΩ, 2 × Aux 100mV/470 kΩ	5 × Mic 0.6mV/4.7kΩ, 1 × Aux 100mV/470 kΩ 1 × Aux 200mV/250kΩ (RCA Jack)
FREQUENCY RESPONSE	65-15,000Hz ±3dB	70-15,000Hz ±3dB
SIGNAL TO NOISE RATIO	60dB	60dB
TONE CONTROLS	Bass: -10dB at 100Hz, Treble: -10dB at 10kHz	Bass: -10dB at 100Hz, Treble: -10dB at 10kHz
OUTPUTS	Preamp 200mV/600Ω	Preamp 200mV/600Ω
SPEAKER OUTPUTS	4Ω, 8Ω, 70V & 100V for each zone	4Ω, 8Ω, 16Ω & 100V for each zone
POWER SUPPLY	AC: 220-240V 50/60Hz DC: 12V (12V Car Battery)	AC: 220-240V 50/60Hz DC: 12V (12V Car Battery)
POWER CONSUMPTION	AC: 300VA DC: 6A	AC: 250VA DC: 5A
DIMENSIONS	W460 × H155 × D310 mm	W400 × H130 × D290 mm
WEIGHT	14.20kg	10.10kg

UBA-1300

1300 WATTS ■ AC Operation

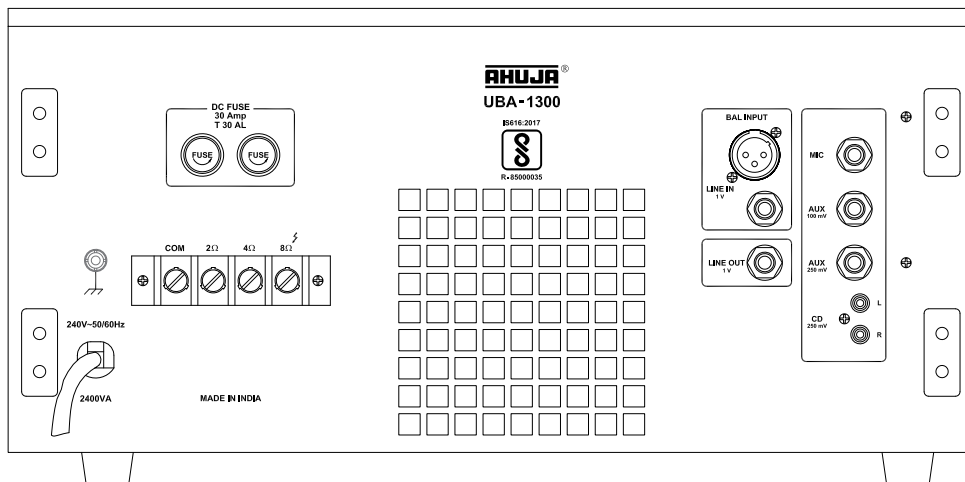

- Designed for use in a wide variety of PA applications and DJ performances.
- UBA-1300 is a 1300 Watts amplifier which can be connected to various input sources like a Microphone, PA Mixer, DJ Mixer, CD Player, Cassette Player, Keyboard etc.
- Equalization through bass and treble controls which enable precise and accurate tonal setting of the sound quality.
- The Sub switch provided facilitates use with sub woofer (without separate crossover).
- Line Input and Line Output have been provided to enable interconnections with other power amplifiers.
- Circuit Protector Device has been provided which safeguards the amplifier against overload and short circuit.
- Built-in protection against over voltage in AC mains supply which is specially useful while operating on a DG set.
- Indicator LEDs for Power, Signal, Temp, Overload and Fault conditions have been provided.
- 2Ω Speaker matching provided in addition to 4Ω & 8Ω.
- BIS approved.

SPECIFICATIONS	UBA-1300
POWER OUTPUT	1650W RMS Max., 1300W RMS at 10%THD, 1150W RMS at 5% THD 1050W RMS at 2% THD
OUTPUT REGULATION	≤ 2dB, no load to full load at 1kHz
INPUT CHANNELS	1 × Mic 1.5mV / 4.7kΩ, 1 × Aux 100mV / 470kΩ, 1 × Aux 250mV / 20kΩ, 1 × CD 250mV / 20kΩ, 1 × Line 1V / 10kΩ unbalanced, 20k balanced
FREQUENCY RESPONSE	50Hz – 18,000Hz ± 3dB
SIGNAL TO NOISE RATIO	60dB
TONE CONTROLS	Bass (100Hz) : ± 8dB Treble (10kHz) : ± 8dB
SPEAKER OUTPUT	2Ω, 4Ω & 8Ω
POWER SUPPLY	AC: 220-240V 50/60Hz
PROTECTIONS	2 × 30A fuse in ± DC supply, 10A circuit breaker in AC mains Protected against high AC mains voltage, overload & temperature
POWER CONSUMPTION	2400VA
DIMENSIONS	W500 × H225 × D577 mm
WEIGHT	49.60kg

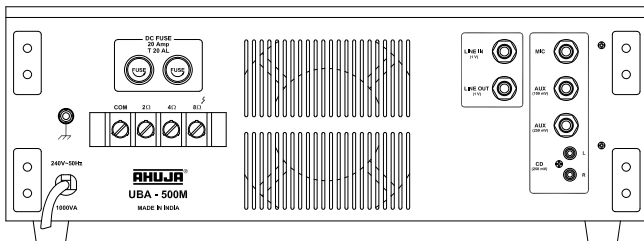
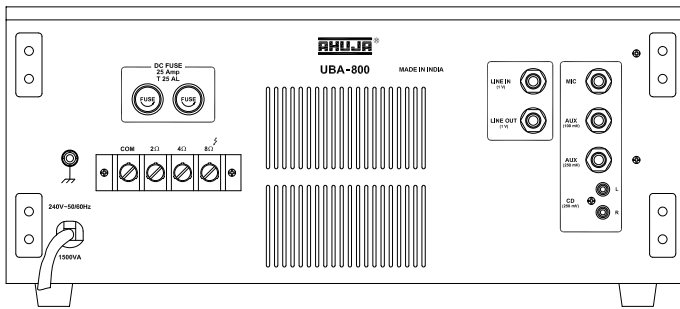

UBA-800®

800 WATTS ■ AC Operation

- Designed for use in a wide variety of PA applications and DJ performances.
- UBA-800® is a 800 Watts amplifier which can be connected to various input sources like a Microphone, PA Mixer, DJ Mixer, CD Player, Cassette Player, Keyboard etc.
- The amplifier includes an built-in 5 Band Graphic Equalizer with tone ON/OFF switch which enables precise and accurate tonal setting of the programme.
- Line Input and Line Output have been provided to enable interconnections with other power amplifiers.
- Circuit Protector Device has been provided which safeguards the amplifier against overload and short circuit.
- The amplifier has built-in protection against over voltage in AC mains supply which is specially useful while operating on a DG set.
- Indicator LEDs for Power, Signal, Temp, Overload and Fault conditions have been provided.
- 2Ω speaker matching provided in addition to 4 & 8Ω.

UBA-500®M

500 WATTS ■ AC Operation

- Designed for use in a wide variety of PA applications and DJ performances.
- UBA-500®M is a 500 Watts amplifier which can be connected to various input sources like a Microphone, PA Mixer, DJ Mixer, CD Player, Cassette Player, Keyboard etc.
- The amplifier includes an built-in 5 Band Graphic Equalizer with tone ON/OFF switch which enables precise and accurate tonal setting of the programme.
- Features are similar to UBA-800®.

SPECIFICATIONS	UBA-800®	UBA-500®M
POWER OUTPUT	1150W RMS Max., 800W RMS at 10%THD 770W RMS at 5% THD 725W RMS at 2% THD	650W RMS Max., 500W RMS at 10%THD 475W RMS at 5% THD 450W RMS at 2% THD
OUTPUT REGULATION	≤ 2dB, no load to full load at 1kHz	≤ 2dB, no load to full load at 1kHz
INPUT CHANNELS	1 × Mic 1mV / 4.7kΩ, 1 × Aux 100mV / 470kΩ, 1 × Aux 250mV / 20kΩ 1 × CD 250mV / 20kΩ, 1 × Line 1V / 10kΩ	1 × Mic 1mV / 4.7kΩ, 1 × Aux 100mV / 470kΩ, 1 × Aux 250mV / 20kΩ 1 × CD 250mV / 20kΩ, 1 × Line 1V / 10kΩ
FREQUENCY RESPONSE	50Hz – 18,000Hz ±3dB	50Hz – 18,000Hz ±3dB
SIGNAL TO NOISE RATIO	60dB	60dB
TONE CONTROLS	Bass (100Hz) : ± 8dB Lo-Mid (315Hz) : ± 8dB Mid (1kHz) : ± 8dB Hi-Mid (3.1kHz) : ± 8dB Treble (10kHz) : ± 8dB	Bass (100Hz) : ± 8dB Lo-Mid (315Hz) : ± 8dB Mid (1kHz) : ± 8dB Hi-Mid (3.1kHz) : ± 8dB Treble (10kHz) : ± 8dB
LINE OUTPUT	1V/1kΩ	1V/1kΩ
SPEAKER OUTPUT	2Ω, 4Ω & 8Ω	2Ω, 4Ω & 8Ω
POWER SUPPLY	AC: 220-240V 50/60Hz	AC: 220-240V 50/60Hz
PROTECTIONS	2 × 25A fuse in ± DC supply, 8A circuit breaker in AC mains Protected against high AC mains voltage, overload & temperature	2 × 20A fuse in ± DC supply, 5A circuit breaker in AC mains Protected against high AC mains voltage, overload & temperature
POWER CONSUMPTION	1500 VA	1000 VA
DIMENSIONS	W482 × H186 × D512 mm	W482 × H166 × D435 mm
WEIGHT	33.00kg	22.50kg

SPA-25000

2500 WATTS ■ AC Operation

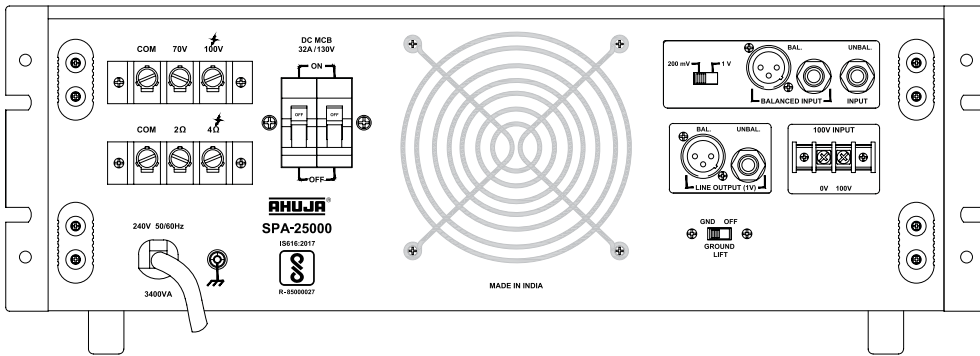

High power single channel PA Power Amplifier, specially designed for big installations where large number of speakers are required. Class H operation for optimum efficiency

- Line Input 200mV/1V switchable for connecting a mixer or another amplifier.
- 100V input for connecting to another amplifier 100V output.
- Built-in circuit for protection against overload, short circuit and temperature.
- Built-in protection against overvoltage in AC mains supply which is specially useful while operating on a DG set.
- Box Speaker/Driver Unit selector switch. Bass boost defeated at Driver Unit position for safer operation of driver units.
- 100V/70V, 4Ω and 2Ω power outputs
- Ideal for large installations where very high power output is required.
- BIS approved.

SPECIFICATIONS	SPA-25000
POWER OUTPUT	3000W Max., 2500W RMS at 10% THD 2300W RMS at 5% THD, 2150W RMS at 2% THD
OUTPUT REGULATION	≤ 2 dB, no load to full load at 1kHz
INPUT CHANNELS	1 × Line 200mV/20kΩ balanced, 10kΩ unbalanced, 1 × Line 1V/20kΩ balanced, 10kΩ unbalanced, 1 × 100V Input/100kΩ
FREQUENCY RESPONSE	50-15,000Hz ±3dB
SIGNAL TO NOISE RATIO	75dB
TONE CONTROLS	Bass: ±10dB at 100Hz, Treble: ±10dB at 10kHz
SPEAKER OUTPUTS	2Ω, 4Ω, 70V & 100V
POWER SUPPLY	AC: 220-240V 50/60Hz
POWER CONSUMPTION	AC: 3400VA
DIMENSIONS	W520 × H185 × D595 mm
WEIGHT	38.50kg

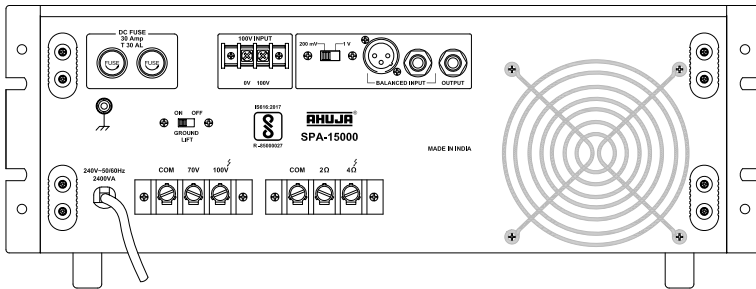

SPA-15000

1500 WATTS ■ AC Operation

- Line Input 200mV/1V switchable for connecting a PA mixer or another amplifier.
- 100V input for connecting to another amplifier 100V output.
- Resettable circuit breaker for protection against overload and short circuit.
- Box Speaker/Driver Unit selector switch. Bass boost defeated at Driver Unit position for safer operation of driver units.
- 100V/70V, 4Ω and 2Ω power outputs
- Ideal for large installations where very high power output is required.
- BIS approved.

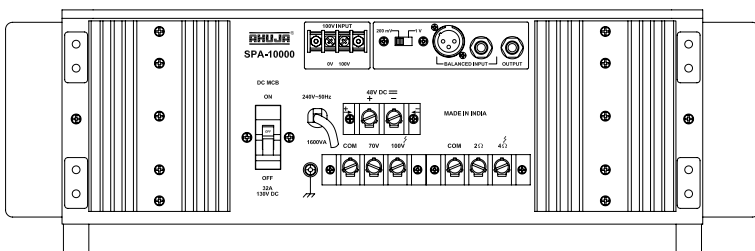

SPA-10000®

1000 WATTS ■ AC & 48V DC Operation

- Line Input 200mV/1V switchable for connecting a PA mixer or another amplifier.
- 100V input for connecting another amplifier output.
- Resettable circuit breaker for protection against overload and short circuit.
- Instant transfer to DC power if AC power fails.
- Box Speaker/Driver Unit selector switch. Bass boost defeated at Driver Unit position for safer operation of driver units.
- Ideal for large installations where a high power output is required. A combination of a SSA-10000 and one SPA-10000 can deliver 2000W power output.

SPECIFICATIONS

	SPA-15000	SPA-10000®
POWER OUTPUT	2000W Max., 1500W RMS at 10% THD 1400W RMS at 5% THD, 1250W RMS at 2% THD	1350W Max., 1000W RMS at 10% THD 850W RMS at 5% THD, 800W RMS at 2% THD
OUTPUT REGULATION	≤ 2 dB, no load to full load at 1kHz	≤ 2 dB, no load to full load at 1kHz
INPUT CHANNELS	1 × Line 200mV/100kΩ, 1 × Line 1V/50kΩ, 1 × 100V Input/100kΩ	1 × Line 200mV/100kΩ, 1 × Line 1V/50kΩ, 1 × 100V Input/50kΩ
FREQUENCY RESPONSE	50-15,000Hz ±3dB	50-15,000Hz ±3dB
SIGNAL TO NOISE RATIO	60dB	60dB
TONE CONTROLS	Bass: ±8dB at 100Hz, Treble: ±8dB at 10kHz	Bass: ±10dB at 100Hz, Treble: ±10dB at 10kHz
SPEAKER OUTPUTS	2Ω, 4Ω, 70V & 100V	2Ω, 4Ω, 70V & 100V
POWER SUPPLY	AC: 220-240V 50/60Hz	AC: 220-240V 50/60Hz DC: 48V (4×12V Car Battery)
POWER CONSUMPTION	AC: 2400VA	AC: 1600VA DC: 12A
DIMENSIONS	W485 × H170 × D580 mm	W540 × H185 × D510 mm
WEIGHT	41.10kg	41.00kg



SPA-5000[®]EM

500 WATTS ■ AC & 36V DC Operation

- Line Input 200mV/1V switchable for connecting a PA mixer or another amplifier.
- Resettable circuit breaker for protection against overload and short circuit.
- Instant transfer to DC power (Car Battery) if AC power fails.
- Box Speaker/Driver Unit selector switch. Bass boost defeated at Driver Unit position for safer operation of driver units.
- Ideal for large installations where a high power output is required. A combination of a SSA-5000EM and one SPA-5000EM can deliver 1000W power output.

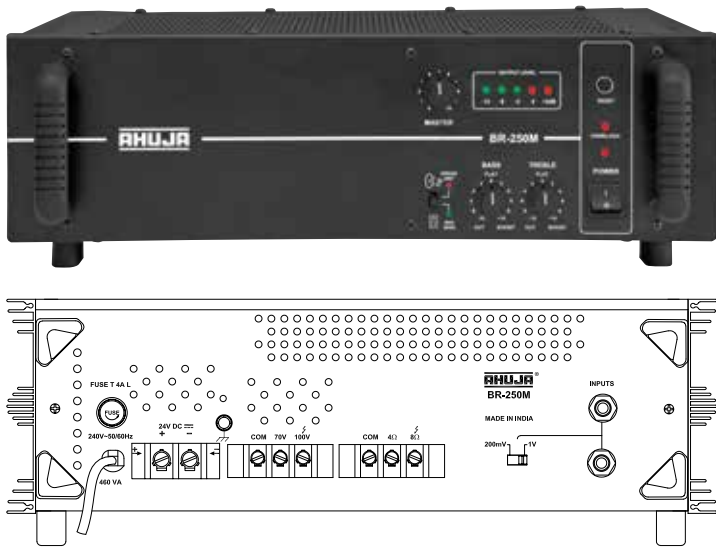

BR-250M

250 WATTS ■ AC & 24V DC Operation

- Line Input 200mV/1V switchable for connecting a PA mixer or another amplifier.
- Resettable circuit breaker for protection against overload and short circuit. Instant transfer to DC power (Car Battery) if AC power fails.
- Box Speaker/Driver Unit selector switch. Bass boost defeated at Driver Unit position for safer operation of driver units.
- By connecting four booster amplifiers BR-250M to one SSA-250M, the user can have a 1250W mono system.
- Instant transfer to DC power (Car Battery) if AC power fails.

SPECIFICATIONS	SPA-5000 [®] EM	BR-250M
POWER OUTPUT	750W Max., 500W RMS at 10% THD 450W RMS at 5% THD, 415W RMS at 2% THD	300W Max., 250W RMS at 10% THD 220W RMS at 5% THD, 200W RMS at 2% THD
OUTPUT REGULATION	≤ 2 dB, no load to full load at 1kHz	≤ 2 dB, no load to full load at 1kHz
INPUT CHANNELS	1 × Line 200mV/100kΩ 1 × Line 1V/50kΩ	1 × Line 200mV/100kΩ 1 × Line 1V/50kΩ
FREQUENCY RESPONSE	50-15,000Hz ±3dB	50-15,000Hz ±3dB
SIGNAL TO NOISE RATIO	60dB	60dB
TONE CONTROLS	Bass: ±10dB at 100Hz, Treble: ±10dB at 10kHz	Bass: ±10dB at 100Hz, Treble: ±10dB at 10kHz
SPEAKER OUTPUTS	4Ω, 8Ω, 70V & 100V	4Ω, 8Ω, 70V & 100V
POWER SUPPLY	AC: 220-240V 50/60Hz DC: 36V (3 × 12V Car Battery)	AC: 220-240V 50/60Hz DC: 24V (2 × 12V Car Battery)
POWER CONSUMPTION	AC: 1000VA DC: 8A	AC: 460VA DC: 6A
DIMENSIONS	W510 × H172 × D385 mm	W450 × H160 × D340 mm
WEIGHT	25.70kg	15.00kg



SSA-10000®

1000 WATTS ■ AC & 48V DC Operation

- 8 Mic & 4 Aux Inputs. Aux-4 input is through RCA socket specially for connecting CD/DVD player.
- Preamplifier and Line Output for connecting to a Booster Amplifier and for recording the programme.
- Line Input for connecting the output from any external PA mixer or permitting SSA-10000 to be used as a Booster Power Amplifier.
- Resettable circuit breaker & MCB at back for protection against overload and short circuit.
- Instant transfer to DC power if AC power fails.
- Box Speaker/Driver Unit selector switch. Bass boost defeated at Driver Unit position for safer operation of driver units.



SSA-7000

700 WATTS ■ AC & 36V DC Operation

- 7 Mic & 3 Aux Inputs.
- Preamplifier and Line Output for connecting to a Booster Amplifier and for recording the programme.
- Line Input for connecting the output from any external PA mixer or permitting SSA-7000 to be used as a Booster Power Amplifier.
- Resettable circuit breaker for protection against overload and short circuit.
- Instant transfer to DC power if AC power fails.
- Box Speaker/Driver Unit selector switch. Bass boost defeated at Driver Unit position for safer operation of driver units.

SPECIFICATIONS	SSA-10000®	SSA-7000
POWER OUTPUT	1350W Max., 1000W RMS at 10% THD 850W RMS at 5% THD, 800W RMS at 2% THD	950W Max., 700W RMS at 10% THD 600W RMS at 5% THD, 570W RMS at 2% THD
OUTPUT REGULATION	≤ 2 dB, no load to full load at 1kHz	≤ 2 dB, no load to full load at 1kHz
INPUT CHANNELS	8 × Mic 0.8mV/4.7kΩ, 3 × Aux 100mV/50kΩ 1 × Aux 250mV/50kΩ, 1 × Line 1V/50kΩ	7 × Mic 0.8mV/4.7kΩ, 2 × Aux 100mV/50kΩ 1 × Aux 250mV/50kΩ, 1 × Line 1V/50kΩ
FREQUENCY RESPONSE	50-15,000Hz ±3dB	50-15,000Hz ±3dB
SIGNAL TO NOISE RATIO	60dB	60dB
TONE CONTROLS	Bass: ±10dB at 100Hz, Treble: ±10dB at 10kHz	Bass: ±10dB at 100Hz, Treble: ±10dB at 10kHz
OUTPUTS	Preamp 200mV/600Ω, Line 1V/1kΩ	Preamp 200mV/600Ω, Line 1V/1kΩ
SPEAKER OUTPUTS	2Ω, 4Ω, 70V & 100V	2Ω, 4Ω, 70V & 100V
POWER SUPPLY	AC: 220-240V 50/60Hz DC: 48V (4 × 12V Car Battery)	AC: 220-240V 50/60Hz DC: 36V (3 × 12V Car Battery)
POWER CONSUMPTION	AC: 1600VA DC: 12A	AC: 1100VA DC: 11A
DIMENSIONS	W540 × H185 × D510 mm	W510 × H185 × D400 mm
WEIGHT	42.00kg	38.00kg

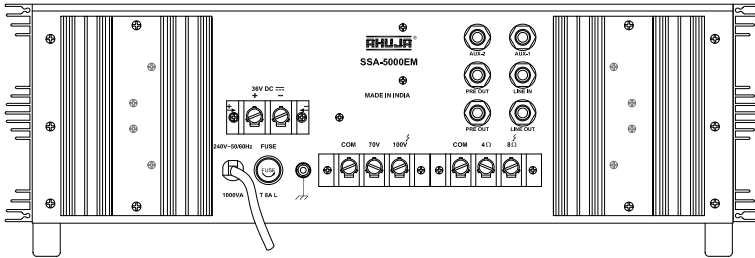

SSA-5000[®]EM

500 WATTS ■ AC & 36V DC Operation

- 7 Mic & 2 Aux Inputs.
- Preamp and Line Output for connecting to a Booster Amplifier and for recording the programme.
- Line Input for connecting the output from any external PA mixer or permitting SSA-5000EM to be used as a Booster Power Amplifier.
- Resettable circuit breaker for protection against overload and short circuit.
- Instant transfer to DC power (Car Battery) if AC power fails.
- Box Speaker/Driver Unit selector switch. Bass boost defeated at Driver Unit position for safer operation of driver units.

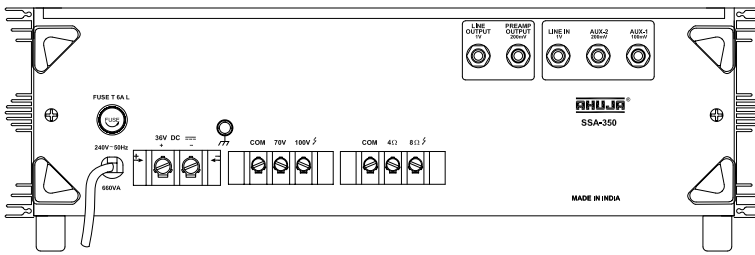

SSA-350

350 WATTS ■ AC & 36V DC Operation

- 7 Mic & 2 Aux Inputs.
- Preamp and Line Output for connecting to a Booster Amplifier and for recording the programme.
- Line Input for connecting the output from any external PA mixer or permitting SSA-350 to be used as a Booster Power Amplifier.
- Resettable circuit breaker for protection against overload and short circuit. Instant transfer to DC power (Car Battery) if AC power fails.
- Box Speaker/Driver Unit selector switch. Bass boost defeated at Driver Unit position for safer operation of driver units.
- Instant transfer to DC power (Car Battery) if AC power fails.

Ahuja models SSA-5000[®]EM and SSA-350 are highly reliable PA Mixer Amplifiers. These are designed to give high power clean sound and trouble free operation under extreme climatic conditions.

SPECIFICATIONS	SSA-5000 [®] EM	SSA-350
POWER OUTPUT	750W Max., 500W RMS at 10% THD 450W RMS at 5% THD, 415W RMS at 2% THD	450W Max., 350W RMS at 10% THD 320W RMS at 5% THD, 300W RMS at 2% THD
OUTPUT REGULATION	≤ 2 dB, no load to full load at 1kHz	≤ 2 dB, no load to full load at 1kHz
INPUT CHANNELS	7 × Mic 0.8mV/4.7kΩ, 2 × Aux 100mV/470 kΩ 1 × Line 1V/50kΩ	7 × Mic 0.8mV/4.7kΩ, 1 × Aux 100mV/470kΩ 1 × Aux 200mV/470kΩ, 1 × Line 1V/50kΩ
FREQUENCY RESPONSE	50-15,000Hz ±3dB	50-15,000Hz ±3dB
SIGNAL TO NOISE RATIO	60dB	60dB
TONE CONTROLS	Bass: ±10dB at 100Hz, Treble: ±10dB at 10kHz	Bass: ±10dB at 100Hz, Treble: ±10dB at 10kHz
OUTPUTS	Preamp 200mV/600Ω, Line 1V/1kΩ	Preamp 200mV/600Ω, Line 1V/1kΩ
SPEAKER OUTPUTS	4Ω, 8Ω, 70V & 100V	4Ω, 8Ω, 70V & 100V
POWER SUPPLY	AC: 220-240V 50/60Hz DC: 36V (3 × 12V Car Battery)	AC: 220-240V 50/60Hz DC: 36V (3 × 12V Car Battery)
POWER CONSUMPTION	AC: 1000VA DC: 8A	AC: 660VA DC: 6A
DIMENSIONS	W510 × H172 × D385 mm	W480 × H160 × D360 mm
WEIGHT	26.70kg	20.50kg



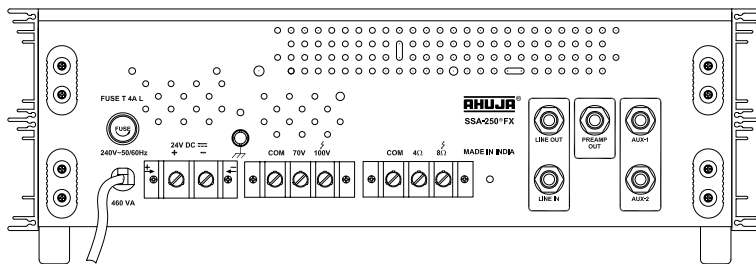
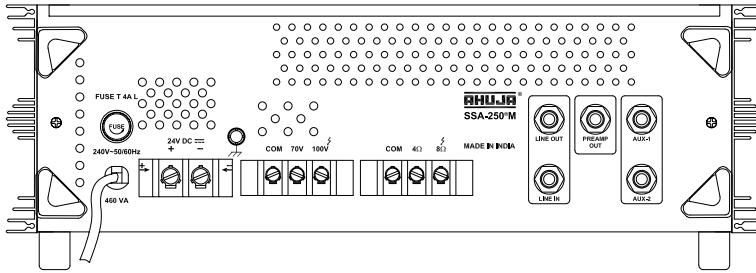

SSA-250®M

250 WATTS ■ AC & 24V DC Operation

- 6 Mic & 2 Aux Inputs.
- Preamplifier and Line Output for connecting to a Booster Amplifier and for recording the programme.
- Line Input for connecting the output from any external PA mixer or permitting SSA-250®M to be used as a Booster Power Amplifier.
- Resettable circuit breaker for protection against overload and short circuit. Instant transfer to DC power (Car Battery) if AC power fails.
- Box Speaker/Driver Unit selector switch. Bass boost defeated at Driver Unit position for safer operation of driver units.
- Instant transfer to DC power (Car Battery) if AC power fails.

SSA-250®FX

250 WATTS ■ AC & 24V DC Operation

- 6 Mic & 2 Aux Inputs.
- Built-in digital effect processor for 2 Mic Inputs.
- Preamplifier and Line Output for connecting to a Booster Amplifier and for recording the programme.
- Line Input for connecting the output from any external PA mixer or permitting SSA-250®FX to be used as a Booster Power Amplifier.
- Resettable circuit breaker for protection against overload and short circuit. Instant transfer to DC power (Car Battery) if AC power fails.
- Box Speaker/Driver Unit selector switch. Bass boost defeated at Driver Unit position for safer operation of driver units.
- Instant transfer to DC power (Car Battery) if AC power fails.

SPECIFICATIONS	SSA-250®M	SSA-250®FX
POWER OUTPUT	300W Max., 250W RMS at 10% THD 220W RMS at 5% THD, 200W RMS at 2% THD	300W Max., 250W RMS at 10% THD 220W RMS at 5% THD, 200W RMS at 2% THD
OUTPUT REGULATION	≤ 2 dB, no load to full load at 1kHz	≤ 2 dB, no load to full load at 1kHz
INPUT CHANNELS	6 × Mic 0.65mV/4.7kΩ, 2 × Aux 100mV/470 kΩ, 1 × Line 1V/50kΩ	6 × Mic 0.65mV/4.7kΩ, 2 × Aux 100mV/470 kΩ, 1 × Line 1V/50kΩ
DELAY SYSTEM	—	Digital Signal Processing
DELAY RANGE SETTING	—	60-300ms
FREQUENCY RESPONSE	50-15,000Hz ±3dB	50-15,000Hz ±3dB
SIGNAL TO NOISE RATIO	60dB	60dB
TONE CONTROLS	Bass: ±10dB at 100Hz, Treble: ±10dB at 10kHz	Bass: ±10dB at 100Hz, Treble: ±10dB at 10kHz
OUTPUTS	Preamp 200mV/600Ω, Line 1V/1kΩ	Preamp 200mV/600Ω, Line 1V/1kΩ
SPEAKER OUTPUTS	4Ω, 8Ω, 70V & 100V	4Ω, 8Ω, 70V & 100V
POWER SUPPLY	AC: 220-240V 50/60Hz DC: 24V (2 × 12V Car Battery)	AC: 220-240V 50/60Hz DC: 24V (2 × 12V Car Battery)
POWER CONSUMPTION	AC: 460VA DC: 6A	AC: 460VA DC: 6A
DIMENSIONS	W450 × H160 × D340 mm	W450 × H160 × D340 mm
WEIGHT	15.40kg	15.70kg



SSA-160[®]EM

160 WATTS ■ AC & 24V DC Operation

- 5 Mic & 2 Aux Inputs.
- Preamp and Line Output for connecting to a Booster Amplifier and for recording the programme.
- Line Input for connecting the output from any external PA mixer or permitting SSA-160[®]EM to be used as a Booster Power Amplifier.
- Resettable circuit breaker for protection against overload and short circuit.
- Instant transfer to DC power (Car Battery) if AC power fails.
- Box Speaker/Driver Unit selector switch. Bass boost defeated at Driver Unit position for safer operation of driver units.



SSA-100[®]M

100 WATTS ■ AC & 24V DC Operation

- 5 Mic & 2 Aux Inputs.
- Preamp and Line Output for connecting to a Booster Amplifier and for recording the programme.
- Instant transfer to DC power (Car Battery) if AC power fails.
- Bass & Treble Tone Controls cut type.



SSB-120[®]

120 WATTS ■ AC & 12V DC Operation

- 5 Mic & 2 Aux Inputs.
- Line Output for connecting to a Booster Amplifier and Preamp Output for recording the programme.
- Cut type Bass & Treble controls.
- Instant transfer to DC power (Car Battery) if AC power fails.

SPECIFICATIONS	SSA-160 [®] EM	SSA-100 [®] M	SSB-120 [®]
POWER OUTPUT	220W Max., 160W RMS at 10% THD 140W RMS at 5% THD, 120W RMS at 2% THD	130W Max., 100W RMS at 10% THD 90W RMS at 5% THD, 80W RMS at 2% THD	160W Max., 120W RMS at 10% THD 105W RMS at 5% THD, 95W RMS at 2% THD
OUTPUT REGULATION	≤ 2 dB, no load to full load at 1kHz	≤ 2 dB, no load to full load at 1kHz	—
INPUT CHANNELS	5 × Mic 0.65mV/4.7kΩ, 2 × Aux 100mV/470 kΩ, 1 × Line 1V/50kΩ	5 × Mic 0.65mV/4.7kΩ, 1 × Aux 50mV/470kΩ 1 × Aux 150mV/470kΩ	5 × Mic 0.65mV/4.7kΩ, 2 × Aux 100mV/470 kΩ
FREQUENCY RESPONSE	50-15,000Hz ±3dB	50-15,000Hz ±3dB	50-15,000Hz ±3dB
SIGNAL TO NOISE RATIO	60dB	60dB	60dB
TONE CONTROLS	Bass: ±10dB at 100Hz, Treble: ±10dB at 10kHz	Bass: -10dB at 100Hz, Treble: -10dB at 10kHz	Bass: -10dB at 100Hz, Treble: -10dB at 10kHz
OUTPUTS	Preamp 200mV/600Ω, Line 1V/1kΩ	Preamp 200mV/600Ω, Line 1V/1kΩ	Preamp 200mV/600Ω, Line 1V/1kΩ
SPEAKER OUTPUTS	4Ω, 8Ω, 70V & 100V	4Ω, 8Ω, 16Ω, 70V & 100V	4Ω, 8Ω, 16Ω, 70V & 100V
POWER SUPPLY	AC: 220-240V 50/60Hz DC: 24V (2 × 12V Car Battery)	AC: 220-240V 50/60Hz DC: 24V (2 × 12V Car Battery)	AC: 220-240V 50/60Hz DC: 12V (12V Car Battery)
POWER CONSUMPTION	AC: 300VA DC: 4A	AC: 220VA DC: 3A	AC: 250VA DC: 5.5A
DIMENSIONS	W420 × H155 × D320 mm	W420 × H135 × D290 mm	W420 × H135 × D295 mm
WEIGHT	13.60kg	10.50kg	11.30kg



SSB-85FX

80 WATTS ■ AC & 12V DC Operation

- 4 Mic & 1 Aux Inputs.
- Built-in digital echo effect on Mic-4.
- Mic-3 is alternate to Aux through switch.
- Mic-1 & Mic-2 having LO-CUT facility.
- Preamplifier Output for connecting to a Booster Amplifier and for recording the programme.
- Cut type Bass & Treble controls.
- Instant transfer to DC power (Car Battery) if AC power fails.



SSB-80[®]M

80 WATTS ■ AC & 12V DC Operation

- 5 Mic & 2 Aux Inputs.
- Preamplifier Output for connecting to a Booster Amplifier and for recording the programme.
- Cut type Bass & Treble controls.
- Instant transfer to DC power (Car Battery) if AC power fails.



SSB-60[®]EM

65 WATTS ■ AC & 12V DC Operation

- 4 Mic & 1 Aux Inputs.
- Preamplifier Output for connecting to a Booster Amplifier and for recording the programme.
- Instant transfer to DC power (Car Battery) if AC power fails.
- Cut type Bass & Treble Controls.

SPECIFICATIONS	SSB-85FX	SSB-80 [®] M	SSB-60 [®] EM
POWER OUTPUT	110W Max., 80W RMS at 10% THD 75W RMS at 5% THD, 60W RMS at 2% THD	110W Max., 80W RMS at 10% THD 75W RMS at 5% THD, 60W RMS at 2% THD	90W Max., 65W RMS at 10% THD 60W RMS at 5% THD, 50W RMS at 2% THD
OUTPUT REGULATION	≤ 2 dB, no load to full load at 1kHz	≤ 2 dB, no load to full load at 1kHz	≤ 2 dB, no load to full load at 1kHz
INPUT CHANNELS	4 × Mic 0.65mV/4.7kΩ, 1 × Aux 100mV/470kΩ	5 × Mic 0.65mV/4.7kΩ, 2 × Aux 100mV/470kΩ	4 × Mic 0.65mV/4.7kΩ, 1 × Aux 100mV/470 kΩ
FREQUENCY RESPONSE	65-15,000Hz ±3dB	65-15,000Hz ±3dB	50-15,000Hz ±3dB
SIGNAL TO NOISE RATIO	60dB	60dB	60dB
TONE CONTROLS	Bass: -10dB at 100Hz, Treble: -10dB at 10kHz	Bass: -10dB at 100Hz, Treble: -10dB at 10kHz	Bass: -10dB at 100Hz, Treble: -10dB at 10kHz
OUTPUTS	Preamp 200mV/600Ω	Preamp 200mV/600Ω	Preamp 200mV/600Ω
SPEAKER OUTPUTS	4Ω, 8Ω, 16Ω, 70V & 100V	4Ω, 8Ω, 16Ω, 70V & 100V	4Ω, 8Ω, 16Ω & 100V
POWER SUPPLY	AC: 220-240V 50/60Hz DC: 12V (12V Car Battery)	AC: 220-240V 50/60Hz DC: 12V (12V Car Battery)	AC: 220-240V 50/60Hz DC: 12V (12V Car Battery)
POWER CONSUMPTION	AC: 180VA DC: 3A	AC: 180VA DC: 3A	AC: 160VA DC: 3A
DIMENSIONS	W355 × H133 × D285 mm	W355 × H133 × D285 mm	W350 × H120 × D265 mm
WEIGHT	8.53kg	7.83kg	7.00kg



SSB-45[®]EM

45 WATTS ■ AC & 12V DC Operation

- 3 Mic & 1 Aux Inputs.
- Pre-amplifier Output for connecting to a Booster Amplifier and for recording the programme.
- Instant transfer to DC power (Car Battery) if AC power fails.
- Cut type Bass & Treble Controls.



UTR-40

30 WATTS ■ AC, 12V DC & Dry Cells Operation

- 3 Mic & 1 Aux Input.
- Cut type Bass & Treble controls.
- 3 POWER SOURCE Amplifier: AC mains, 12V DC (Car Battery) and 12V DC Dry Cell (Two Banks of 8×1.5V Um-1 cell each).
- Extremely portable and ideal for use in remote places without electricity.
- Low current consumption for long battery life.



UTR-30E

25 WATTS ■ AC, 12V DC & Dry Cells Operation

- 3 Mic & 1 Aux Input.
- Cut type Tone control.
- 3 POWER SOURCE Amplifier: AC mains, 12V DC (Car Battery) and 12V DC Dry Cell (Two Banks of 8×1.5V UM-1 cell each).
- Extremely portable and ideal for use in remote places without electricity.
- Battery saver switch for long battery life and red LED for low battery indication.

All these models are compact, portable and ideal for most general purpose applications. These are ideal for use in small sized houses of worship and other similar applications. Since these also operate on 12V Car Battery, they are convenient for areas without continuous mains power supply

SPECIFICATIONS	SSB-45 [®] EM	UTR-40	UTR-30E
POWER OUTPUT	64W Max., 45W RMS at 10% THD 40W RMS at 5% THD, 30W RMS at 2% THD	45W Max., 30W RMS at 10% THD	35W RMS Max., 25W RMS at 10% THD
OUTPUT REGULATION	≤ 2 dB, no load to full load at 1kHz	—	—
INPUT CHANNELS	3 × Mic 0.65mV/4.7kΩ, 1 × Aux 100mV/470 kΩ	3 × Mic 0.65mV/4.7kΩ, 1 × Aux 100mV/470kΩ	3 × Mic 1.0mV/10kΩ, 1 × Aux 50mV/250kΩ
FREQUENCY RESPONSE	100-15,000Hz ±3dB	100-15,000Hz ±3dB	150-10,000Hz ±3dB
SIGNAL TO NOISE RATIO	60dB	60dB	60dB
TONE CONTROLS	Bass: -10dB at 100Hz, Treble: -10dB at 10kHz	Bass: -10dB at 100Hz Treble: -10dB at 10kHz	-15dB at 10kHz —
OUTPUTS	Preamp 200mV/600Ω	—	—
SPEAKER OUTPUTS	4Ω, 8Ω, 16Ω & 100V	4Ω, 8Ω, 16Ω & 100V	4Ω, 8Ω & 16Ω
POWER SUPPLY	AC: 220-240V 50/60Hz DC: 12V (12V Car Battery)	AC: 220-240V 50/60Hz, DC: 12V (Car Battery) DC: 12V (Dry Cells 8 × UM-1 Two Banks)	AC: 220-240V 50/60Hz, DC: 12V (Car Battery) DC: 12V (Dry Cells 8 × UM-1 Two Banks)
POWER CONSUMPTION	AC: 110VA DC: 2A	AC: 90VA DC: 1.8A	AC: 80VA DC: 1.2A
DIMENSIONS	W280 × H120 × D270 mm	W280 × H115 × D270 mm	W250 × H115 × D270 mm
WEIGHT	4.80kg	5.30kg	4.30kg





UB-30M

25 WATTS ■ AC & 12V DC Operation



- 2 Mic & 1 Aux Input.
- Cut type tone control.
- 2 POWER SOURCE amplifier: AC mains and 12V DC (Car Battery).
- Provision of automatic changeover from AC to Battery operation ensuring continuity of program.
- Protection against wrong battery polarity.

Mobile PA Amplifiers



PA-400^{DS}

40 WATTS ■ 12V DC Operation

- 2 Mic & 1 Aux Input.
- Built-in MP3 player with remote control for USB reader.
- Tone Control.
- 12V Car Battery Operation.
- Two Tone Siren (Wailing & Yelping) with volume control.
- Recommended for use with AHUJA Mic MM-60M & Horn Speakers SUH-25/SUH-40.
- Amplifier mounting bracket supplied.
- Ideal for Police Vehicles, Crowd Control, Ambulances, Publicity Vans, Electioneering etc.



PA-400^S

40 WATTS ■ 12V DC Operation

- 2 Mic & 1 Aux Input.
- 12V Car Battery Operation.
- Two Tone Siren (Wailing & Yelping) with volume control.
- Recommended for use with AHUJA Mic MM-60M & Horn Speakers SUH-25/SUH-40.
- Amplifier mounting bracket supplied.
- Ideal for Police Vehicles, Crowd Control, Ambulances, Publicity Vans, Electioneering etc.



SPECIFICATIONS	UB-30M	PS-400 ^{DS}	PA-400 ^S
POWER OUTPUT	30W RMS Max., 25W RMS at 10% THD	50W Max., 40W RMS at 10% THD	50W Max., 40W RMS at 10% THD
INPUT CHANNELS	2 × Mic 1.0mV / 4.7kΩ, 1 × Aux 100mV / 470kΩ	2 × Mic 1mV/4.7kΩ, 1 × Aux 100mV/330kΩ	2 × Mic 1mV/4.7kΩ, 1 × Aux 100mV/330kΩ
DIGITAL PLAYER	—	MP3 Player with USB Reader	—
FREQUENCY RESPONSE	150-10,000Hz ±3dB	100-10,000Hz ±3dB	100-10,000Hz ±3dB
SIGNAL TO NOISE RATIO	60dB	60dB	60dB
SIREN	—	Two Tones	Two Tones
TONE CONTROLS	-10dB at 10kHz	-10dB at 10kHz	—
SPEAKER OUTPUTS	4Ω, 8Ω & 16Ω & 100V	4Ω, 100V Line	4Ω, 100V Line
POWER SUPPLY	AC: 220-240V 50/60Hz, DC: 12V (Car Battery)	12V DC (Car Battery)	12V DC (Car Battery)
POWER CONSUMPTION	AC: 80VA DC: 1.2A	—	—
DIMENSIONS	W180 × H80 × D260 mm	W190 × H80 × D240 mm	W180 × H80 × D240 mm
WEIGHT	3.00kg	2.30kg	2.10kg



PA-200DS

20 WATTS ■ 12V DC Operation



- 1 Mic Input with volume control.
- Built-in MP3 player with AUX Input.
- Separate USB/AUX volume control.
- 12V Car Battery Operation.
- Two Tone Siren (Wailing & Yelping) with volume control.
- Recommended for use with AHUJA Mic MM-60M & Horn Speakers EHC-10/SUH-15.
- Complies in size with the DIN standard.
- Amplifier mounting bracket supplied alongwith.
- Ideal for Police Vehicles, Crowd Control, Ambulances, Publicity Vans, Electioneering etc.

Vehicle PA Amplifier



PA-200S

20 WATTS ■ 12V DC Operation



- 1 Mic & 1 Aux Input with individual volume control.
- 12V Car Battery Operation.
- Two Tone Siren (Wailing & Yelping) with volume control.
- Recommended for use with AHUJA Mic MM-60M & Horn Speakers EHC-10/SUH-15.
- Complies in size with the DIN standard.
- Amplifier mounting bracket supplied alongwith.
- Ideal for Police Vehicles, Crowd Control, Ambulances, Publicity Vans, Electioneering etc.

Vehicle PA Amplifier



MPA-40S

22 WATTS ■ 12V DC Operation

- 1 Mic Input.
- 12V Motorcycle Battery Operation.
- Two Tone Siren (Wailing & Yelping) with volume control.
- Recommended AHUJA Mic MM-60M with 4 pin connector.
- Supplied with mounting brackets.
- Ideal for Police Motorcycles.

SPECIFICATIONS	PA-200DS	PA-200S	MPA-40S
POWER OUTPUT	30W Max., 20W RMS at 10% THD	30W Max., 20W RMS at 10% THD	22W Max., 16W RMS at 10% THD
INPUT CHANNELS	1 × Mic 5.0mV/4.7kΩ,	1 × Mic 5.0mV/4.7kΩ, 1 × Aux 100mV/330kΩ	Built-in Mic
DIGITAL PLAYER	MP3 Player with USB & SD/MMC Card Reader, 0.5mm AUX Input	—	—
FREQUENCY RESPONSE	250-10,000Hz ±3dB	250-10,000Hz ±3dB	100-10,000Hz ±3dB
SIGNAL TO NOISE RATIO	60dB	60dB	60dB
SIREN	Two Tones	Two Tones	Two Tones
SPEAKER OUTPUTS	4Ω / 20W; 8Ω / 12W	4Ω / 20W; 8Ω / 12W	4Ω Voice Coil
POWER SUPPLY	12V DC (Car Battery)	12V DC (Car Battery)	12V DC (Motorcycle Battery)
DIMENSIONS	W178 × H52 × D157 mm	W178 × H52 × D157 mm	Control Unit: W125 × H95 × D120mm Horn Speaker: Dia 170 × (L190) mm
WEIGHT	1.10kg (with mounting clamp)	1.10kg (with mounting clamp)	Control Unit with Mic 730g Horn Speaker 1.95kg



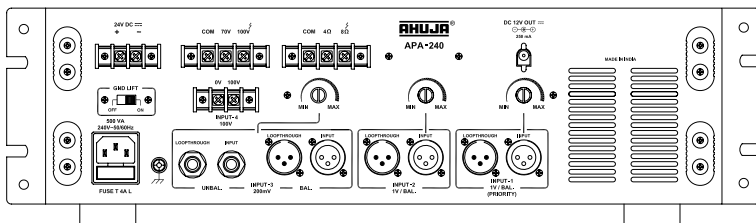
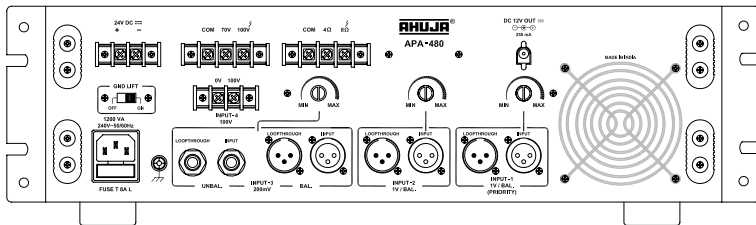

APA-480

600 WATTS ■ AC & 24V DC Operation

- 1x Line 200mV unbalanced input through 1/4" phone socket, 1xLine 200mV balanced input & 2xLine 1V balanced inputs through XLR connectors, one 1V input having priority over all other inputs.
- 100V input is provided for connecting another amplifier's output in long line applications.
- Ground lift switch provided at rear panel which helps reducing the hum that occurs due to multiple ground loops in the installations.
- Resettable circuit breaker for protection against overload and short circuit.
- Loop through output for connecting another booster amplifier.
- 482.6 mm(19") Rack mountable chassis.
- Instant transfer to DC power (Car Battery) if AC power fails.

APA-240

325 WATTS ■ AC & 24V DC Operation

- 1x Line 200mV unbalanced input through 1/4" phone socket, 1x line 200mV balanced input & 2xLine 1V balanced inputs through XLR connectors, one 1V input having priority over all other inputs.
- 100V input is provided for connecting another amplifier's output in long line applications.
- Ground lift switch provided at rear panel which helps reducing the hum that occurs due to multiple ground loops in the installations.
- Resettable circuit breaker for protection against overload and short circuit.
- Loop through output for connecting another booster amplifier.
- 482.6 mm (19") Rack mountable chassis.
- Instant transfer to DC power (Car Battery) if AC power fails.

SPECIFICATIONS

	APA-480	APA-240
POWER OUTPUT	750W Max., 600W RMS at 10% THD 550W RMS at 5% THD, 500W RMS at 2% THD, 480W RMS at 1% THD	415W Max., 325W RMS at 10% THD 300W RMS at 5% THD, 275W RMS at 2% THD, 240W RMS at 1% THD
OUTPUT REGULATION	≤ 2 dB, no load to full load at 1kHz	≤ 2 dB, no load to full load at 1kHz
INPUT CHANNELS	1 × 200mV/470kΩ (unbal.), 1 × 200mV/50kΩ (bal.), 2 × 1V/50kΩ (bal.), 1 × 100V Input/50kΩ	1 × 200mV/470kΩ (unbal.), 1 × 200mV/50kΩ (bal.), 2 × 1V/50kΩ (bal.), 1 × 100V Input/50kΩ
FREQUENCY RESPONSE	50-15,000Hz ±3dB	50-15,000Hz ±3dB
SIGNAL TO NOISE RATIO	60dB	60dB
TONE CONTROLS	Bass: ±10dB at 100Hz, Treble: ±10dB at 10kHz	Bass: ±10dB at 100Hz, Treble: ±10dB at 10kHz
OUTPUTS	Loop through 2 × 200mV/600Ω, 2 × 1V/1kΩ	Loop through 2 × 200mV/600Ω, 2 × 1V/1kΩ
SPEAKER OUTPUTS	4Ω, 8Ω, 70V & 100V	4Ω, 8Ω, 70V & 100V
POWER SUPPLY	AC: 220-240V 50/60Hz DC: 24V (2×12V Car Battery)	AC: 220-240V 50/60Hz DC: 24V (2×12V Car Battery)
POWER CONSUMPTION	AC: 1200VA DC: 15A	AC: 500VA DC: 7A
DIMENSIONS	W485 × H142 × D510 mm	W485 × H142 × D405 mm
WEIGHT	32.20kg	20.60kg

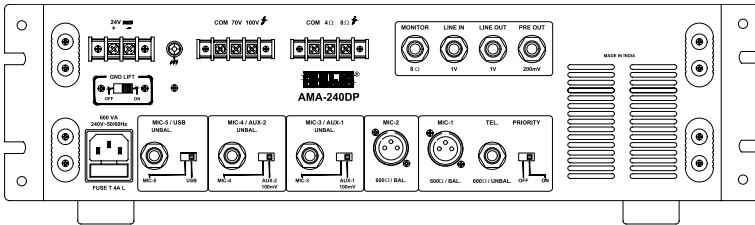

AMA-240DP

325 WATTS ■ AC & 24V DC Operation

- High quality mixer amplifier with built-in MP3 player in standard 482.6 mm (19") rack mountable chassis.
- 3 Unbalanced Mic inputs, 2 balanced Mic inputs, 2 Aux inputs, 1 Telephone & 1 balanced line Input.
- Voice Operated Priority in Mic-1 and Telephone Inputs.
- Preamplifier Output (unbal.) and Line Output (bal.) for recording & connecting a booster amplifier.
- Ground lift switch provided at rear panel which helps reducing the hum that occurs due to multiple ground loops in the installations.
- Resettable circuit breaker for protection against overload and short circuit. Instant transfer to DC power (Car Battery) if AC power fails.

SPECIFICATIONS

AMA-240DP

POWER OUTPUT	415W Max., 325W RMS at 10% THD, 240W RMS at 1% THD
OUTPUT REGULATION	≤ 2 dB, no load to full load at 1kHz
INPUT CHANNELS	3 × Mic 2.5mV/4.7kΩ (unbal.), 2 × Mic 2.0mV/2kΩ (bal.), 1 × Line 1V/50kΩ (Bal.), 2 × Aux 100mV/470kΩ, 1 × Telephone 150mV/10kΩ
FREQUENCY RESPONSE	50-15,000Hz ±3dB
SIGNAL TO NOISE RATIO	60dB
TONE CONTROLS	Bass: ±10dB at 100Hz, Treble: ±10dB at 10kHz
OUTPUTS	Preamp 200mV/600Ω (Unbal.), Line 1V/1kΩ (Bal.), Monitor 5V/8Ω
SPEAKER OUTPUTS	4Ω, 8Ω, 70V & 100V
DIGITAL PLAYER	MP3 Player with USB, SD / MMC Card Reader & Bluetooth
POWER SUPPLY	AC: 220-240V 50/60Hz DC: 24V (2 × 12V Car Battery)
POWER CONSUMPTION	AC: 600VA DC: 7A
DIMENSIONS	W485 × H142 × D405 mm
WEIGHT	21.00kg

Installation PA Mixer with Digital Player

Versatile 17 Channel Rack Mounting Preamplifier

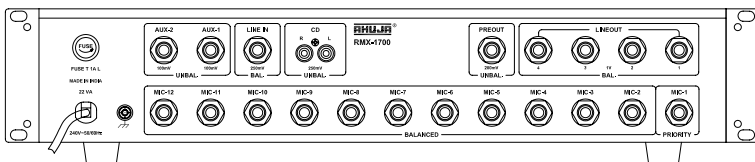

RMX-1700

AC Operation

- Multi-purpose mixer in standard 482.6 mm (19") rack mountable chassis, suitable for a variety of applications.
- 12 Balanced Mic inputs with 2 Aux and 1 Line. Each channel uses 6.3 mm (1/4") balanced phone jack and accepts both balanced and unbalanced signals.
- Mic-1 has priority over all other inputs.
- Dual RCA plugs provided for CD stereo input.
- Independent USB play back channel.
- Active Bass, Treble & Master level control provided.
- Pre amp output for recording purpose provided through 6.3 mm (1/4") Jack. Headphone output for monitoring purpose.
- 4 × balanced Line outputs through 6.3mm (1/4") to connect number of amplifiers or boosters provided.

SPECIFICATIONS

RMX-1700

POWER REQUIREMENT	AC: 220-240V 50/60Hz
OUTPUTS	1 × Preamp 200mV/600Ω, 4 × Line 1V/1kΩ, 1 × Headphone 200mV@ 8Ω
FREQUENCY RESPONSE	20-20,000Hz (±1dB)
DISTORTION	< 1%
SIGNAL TO NOISE RATIO	60dB
INPUT CHANNELS	12 × Mic 0.85mV/2kΩ (bal.), 2 × Aux 100mV/220kΩ (unbal.), 1 × CD 250mV/20kΩ, 1 × Line 250mV/20kΩ (bal.)
DIGITAL PLAYER	MP3 Player with USB, SD and MMC card reader & Bluetooth
TONE CONTROLS	Bass: ± 10dB at 100Hz, Treble: ± 10dB at 10kHz
DIMENSIONS	W483 × H97 × D274 mm
WEIGHT	5.60kg



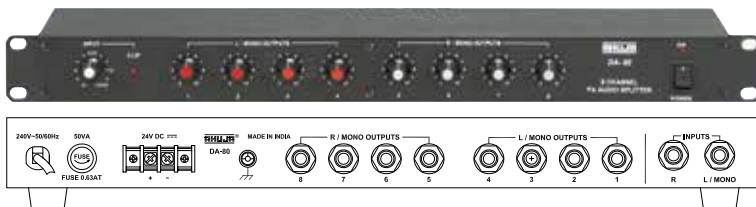
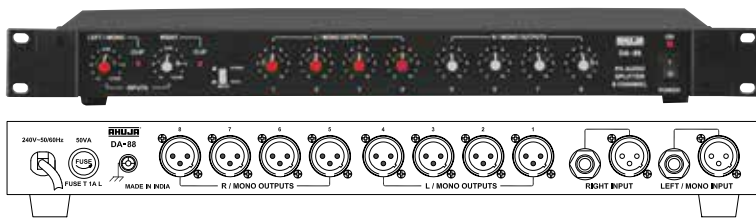

DA-88

AC Operation

- Compact and rugged professional line level signal splitter.
- Designed for use in a wide variety of indoor and outdoor PA applications.
- Accepts Line Level Stereo as well as Mono inputs through F/XLR connector as well as 6.3mm (1/4") stereo phone jack sockets.
- Provides four stereo balanced outputs or eight mono balanced outputs through M/XLR connectors.
- Individual volume control for each input & output channel.
- Separate clip LED indicator for Left and Right input signal.
- Easy to operate Stereo/Mono push switch, provided on front panel.
- Operates on AC mains.
- 482.6 mm (19") rack mountable in 1U size and usable as a table top unit also.

DA-80

AC & 24V DC Operation

- Sleek & compact 8-channel line signal splitter.
- Accepts line level Stereo/Mono input.
- Provides four line level stereo outputs or eight line level mono outputs.
- Individual volume controls for input and eight output channels.
- Clip LED for setting optimum distortion free input levels.
- Operates on AC mains and 24V DC Car Battery.
- 482.6 mm (19") rack mountable in 1U space and also usable as a table top unit.

SPECIFICATIONS	DA-88	DA-80
INPUT CHANNELS	2 × 100mV/20kΩ Balanced	2 × 100mV/47kΩ Unbalanced
OUTPUTS	8 × 1V / 50Ω Balanced	8 × 1V/470Ω Unbalanced
FREQUENCY RESPONSE	20-20,000Hz ±3dB	20-20,000Hz ±3dB
DISTORTION	<0.1%	< 0.1%
SIGNAL TO NOISE RATIO	70dB	70dB
POWER SUPPLY	AC: 220-240V 50/60Hz	AC: 220-240V 50/60Hz, DC: 24V (2 × 12V Car Battery)
DIMENSIONS	W483 × H52 × D195 mm	W483 × H43 × D178 mm
WEIGHT	2.80kg	2.80kg

Digital Player/Recorder



ADP-30R

200mV ■ AC & 12V DC Operation

- Designed for use in a wide variety of PA applications.
- Built-in MP3 recorder player with LCD display supplied with remote control and with built-in facility of USB, SD, MMC card.
- Bluetooth facility.
- ADP-30R has a Preamp output for connecting to Stereo or Mono input of another amplifier and a REC input for recording the preamp output of another amplifier.
- Provision for automatic changeover from AC to Battery Operation ensures continuity of program (if 12V battery is connected).
- Protection provided against the reverse polarity of battery connections.

SPECIFICATIONS	ADP-30R
INPUT CHANNELS	REC Input 200mV Left & Right
FREQUENCY RESPONSE	20-20,000Hz ±1dB
SIGNAL TO NOISE RATIO	60dB
OUTPUT	200mV/600Ω Mono / Stereo
DIGITAL PLAYER	MP3 Recorder Player with USB, SD, MMC Card & Bluetooth
POWER SUPPLY	AC: 220-240V 50/60Hz DC: 12V (12V Car Battery)
POWER CONSUMPTION	AC: 22VA DC: 500mA
DIMENSIONS	W152 × H81 × D165 mm
WEIGHT	1.20kg



Hallmark of Reliability!



PA Amplifiers with built-in Digital Player

USB Flash Drives & SD Cards provide a reliable, lightweight and convenient medium for storing very large numbers of songs in MP3 format. AHUJA MP3 Digital Players are specially designed to reproduce, faithfully and with utmost fidelity, the music stored in MP3 format.

A wide range of highly reliable AHUJA PA Amplifiers are available with built-in MP3 Digital Players to enable easy & convenient music playback.

Applications

Offices | Coaching Classes | Shops | Campaigns | Mobile Publicity

Tourist Coaches | Restaurants

Dual Channel Power Amplifier with Digital Player

ZXA-500DP

250+250 WATTS ■ AC Operation



- Designed for use in wide variety of PA applications specially requiring high quality music.
- Professional dual channel power amplifier.
- 500 Watts rated output.
- Built-in MP3 play back facility with remote control. Backlit LCD display.
- Bluetooth and FM facility.
- Digital recorder facility.
- Cut-Boost type treble and bass control for tonal adjustment.
- Extensive built-in protection circuit for smooth and safe operation.

SPECIFICATIONS

ZXA-500DP

CONTINUOUS RATED POWER	
STEREO/MONO	8Ω : 100W + 100W RMS, 4Ω : 180W + 180W RMS 2Ω : 250W + 250W RMS
THD + N	< 1.0%
FREQUENCY RESPONSE (-1dB)	20-20,000Hz
POWER BANDWIDTH (0.5% THD)	20-20,000Hz
INPUTS	Mic: Mono Phone Jack 6.3mm, CD/Aux: RCA Jack (L&R)
INPUT SENSITIVITY	Mic: 5mV/4.7kΩ (unbal.), CD/Aux: 250mV/10kΩ (L&R) Stereo Mode
SIGNAL TO NOISE RATIO	> 65dB
TONE CONTROLS	Bass: ±10dB at 100Hz, Treble: ±10dB at 10kHz
CHANNEL SEPARATION	> 60dB AT 1kHz
OUTPUT	Line: 1V/1kΩ (L&R) through RCA Jack
DIGITAL PLAYER	MP3 Recorder Player with USB, SD, MMC Card, Bluetooth & FM
PROTECTIONS	Temperature, DC, RFI, Short Circuit, Built-in Limiter AC: Fuse 6A (T 6A L); ± DC: Fuse 2 X 8A (T 8A L) for each channel
OUTPUT CONNECTORS	2 x Heavy duty 2-Way terminal strip
COOLING	DC Fan with Temperature Sensing
INDICATORS	Power ON, Signal, Clip, Protect (Ch. L&R)
POWER CONSUMPTION (RATED)	600VA @ 220-240V ~ 50/60Hz
DIMENSIONS	W393 × H108 × D375mm
WEIGHT	10.50kg

DJ & PA Power Amplifiers with Digital Player

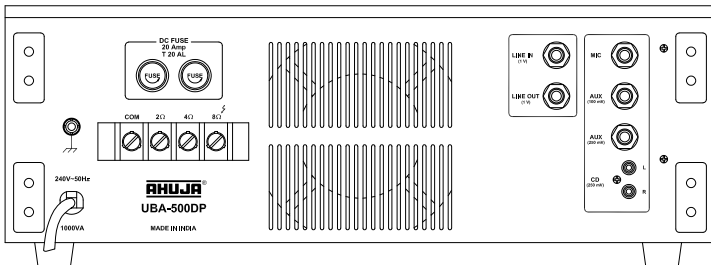
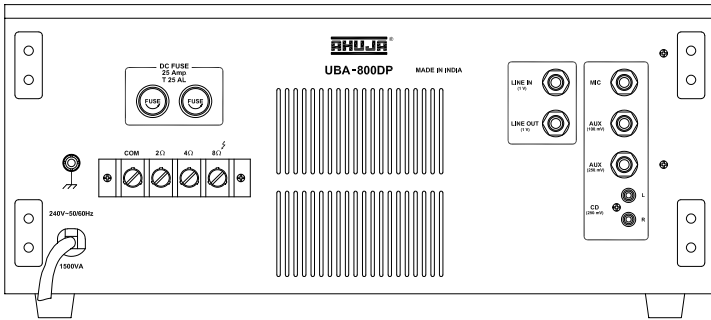

UBA-800®DP

800 WATTS ■ AC Operation

- Designed for use in a wide variety of PA applications and DJ performances.
- Built-in MP3 player with remote control for USB, SD/MMC card reader.
- Bluetooth facility.
- UBA-800 is a 800 Watts amplifier which can be connected to various input sources like a Microphone, PA Mixer, DJ Mixer, CD Player, Cassette Player, Keyboard etc.
- Bass and Treble controls provided for precise and accurate tonal setting of the programme.
- Line Input and Line Output have been provided to enable interconnections with other power amplifiers.
- Circuit Protector Device has been provided which safeguards the amplifier against overload and short circuit.
- The amplifier has built-in protection against over voltage in AC mains supply which is specially useful while operating on a DG Set.
- Indicator LEDs for Power, Signal, Temp, Overload and Fault conditions have been provided.
- 2Ω speaker matching provided in addition to 4 & 8Ω.

UBA-500®DP

500 WATTS ■ AC Operation

- Designed for use in a wide variety of PA applications and DJ performances.
- Built-in MP3 player with remote control for USB, SD/MMC card reader.
- Bluetooth facility.
- UBA-500DP is a 500 Watts amplifier which can be connected to various input sources like a Microphone, PA Mixer, DJ Mixer, CD Player, Cassette Player, Keyboard etc.
- Bass and Treble controls provided for precise and accurate tonal setting of the programme.
- All other features are similar to UBA-800DP.

SPECIFICATIONS	UBA-800®DP	UBA-500®DP
POWER OUTPUT	1150W RMS Max., 800W RMS at 10%THD 770W RMS at 5% THD 725W RMS at 2% THD	650W RMS Max., 500W RMS at 10%THD 475W RMS at 5% THD 450W RMS at 2% THD
OUTPUT REGULATION	≤ 2dB, no load to full load at 1kHz	≤ 2dB, no load to full load at 1kHz
INPUT CHANNELS	1 × Mic 1mV / 4.7kΩ, 1 × Aux 100mV / 470kΩ, 1 × Aux 250mV / 20kΩ 1 × CD 250mV / 20kΩ, 1 × Line 1V / 20kΩ	1 × Mic 1mV / 4.7kΩ, 1 × Aux 100mV / 470kΩ, 1 × Aux 250mV / 20kΩ 1 × CD 250mV / 20kΩ, 1 × Line 1V / 20kΩ
FREQUENCY RESPONSE	50Hz – 18,000Hz ±3dB	50Hz – 18,000Hz ±3dB
SIGNAL TO NOISE RATIO	60dB	60dB
TONE CONTROLS	Bass (100Hz) : ± 8dB Treble (10kHz) : ± 8dB	Bass (100Hz) : ± 8dB Treble (10kHz) : ± 8dB
LINE OUTPUT	1V/1kΩ	1V/1kΩ
SPEAKER OUTPUT	2Ω, 4Ω & 8Ω	2Ω, 4Ω & 8Ω
DIGITAL PLAYER	MP3 Player with USB, SD, MMC Card Reader, Bluetooth	MP3 Player with USB, SD and MMC Card Reader, Bluetooth
POWER SUPPLY	AC: 220-240V 50/60Hz	AC: 220-240V 50/60Hz
PROTECTIONS	2 × 25A fuse in ± DC supply, 8A circuit breaker in AC mains Protected against high AC mains voltage, overload & temperature	2 × 20A fuse in ± DC supply, 5A circuit breaker in AC mains Protected against high AC mains voltage, overload & temperature
POWER CONSUMPTION	1500 VA	1000 VA
DIMENSIONS	W482 × H186 × D512 mm	W482 × H166 × D435 mm
WEIGHT	33.10kg	22.60kg

PA Mixer Amplifiers with Digital Player

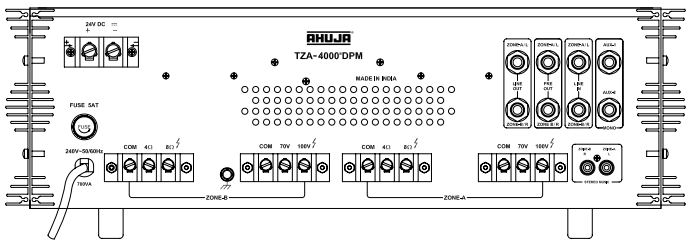
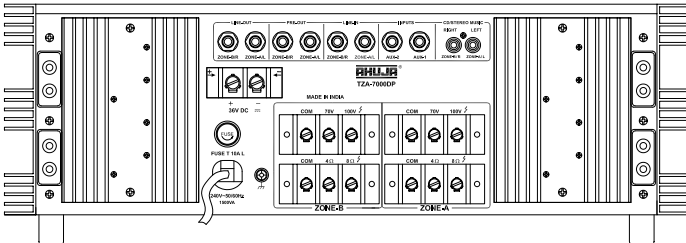

TZA-7000®DP

700 WATTS ■ AC & 36V DC Operation

- 6 Mic, 2 Aux Inputs and CD/Stereo music input (L&R)
- Built-in MP3 player with remote control and LCD display for USB, SD/MMC card reader.
- Bluetooth facility.
- Stereo/Mono switch to change ambience of MP3 music player & CD/Stereo music for DJ programmes.
- Facilitates connection and operation of two separate groups of speakers simultaneously. Ideal for Places of Worship.
- Line Input & Output on each zone for connecting to a PA Mixer and Booster Amplifier respectively. Preamplifier output for recording.
- Box Speaker/Driver Unit selector switch for each zone. Bass boost defeated at Driver Unit position for safer operation of driver units. Zone On/Off facility.
- Resettable circuit breaker for protection against overload and short circuit.
- Instant transfer to DC power (Car Battery) if AC power fails.

TZA-4000®DPM

400 WATTS ■ AC & 24V DC Operation

- 6 Mic, 2 Aux Inputs and CD/Stereo input (L&R).
- Built-in MP3 player with remote control and LCD display for USB, SD/MMC card reader.
- Bluetooth facility.
- Stereo/Mono switch to change ambience of MP3 music player and CD/Stereo music for DJ programmes.
- Separate USB level control provided.
- Line Input & Output on each zone for connecting to a PA Mixer and Booster Amplifier respectively. Preamplifier output for recording.
- Box Speaker/Driver Unit selector switch for each zone. Bass boost defeated at Driver Unit position for safer operation of driver units. Zone On/Off facility.
- Resettable circuit breaker for protection against overload and short circuit.
- Instant transfer to DC power (Car Battery) if AC power fails.

SPECIFICATIONS	TZA-7000®DP	TZA-4000®DPM
POWER OUTPUT	500W + 500W Max., 350W + 350W RMS at 10% THD 300W + 300W RMS at 5% THD, 280W + 280W RMS at 2% THD	300W + 300W Max., 200W + 200W RMS at 10% THD 180W + 180W RMS at 5% THD, 165W + 165W RMS at 2% THD
OUTPUT REGULATION	≤ 2 dB, no load to full load at 1kHz	≤ 2 dB, no load to full load at 1kHz
INPUT CHANNELS	Mic/Aux: 6 × Mic 0.6mV/4.7kΩ, 2 × Aux 100mV/470kΩ Stereo Music Mode: L/R 200mV/100kΩ, Line L/R 1V/20kΩ	Mic/Aux: 6 × Mic 0.6mV/4.7kΩ, 2 × Aux 100mV/470kΩ Stereo Music Mode: L/R 200mV/100kΩ, Line L/R 1V/50kΩ
FREQUENCY RESPONSE	50-15,000Hz ±3dB	50-15,000Hz ±3dB
SIGNAL TO NOISE RATIO	60dB	60dB
TONE CONTROLS	Bass: ±10dB at 100Hz, Treble: ±10dB at 10kHz	Bass: ±10dB at 100Hz, Treble: ±10dB at 10kHz
OUTPUT	Preamp 200mV/600Ω, Line 1V/1kΩ	Preamp 200mV/600Ω, Line 1V/1kΩ
SPEAKER OUTPUT	4Ω, 8Ω, 70V & 100V for each zone	4Ω, 8Ω, 70V & 100V for each zone
DIGITAL PLAYER	MP3 Player with USB, SD and MMC Card Reader, Bluetooth	MP3 Player with USB, SD and MMC Card Reader, Bluetooth
POWER SUPPLY	AC: 220-240V 50/60Hz DC: 36V (3 × 12V Car Battery)	AC: 220-240V 50/60Hz DC: 24V (2 × 12V Car Battery)
POWER CONSUMPTION	AC: 1500VA DC: 13A	AC: 700VA DC: 9A
DIMENSIONS	W510 × H185 × D470 mm	W510 × H172 × D385 mm
WEIGHT	40.00kg	24.20kg

PA Mixer Amplifiers with Digital Player

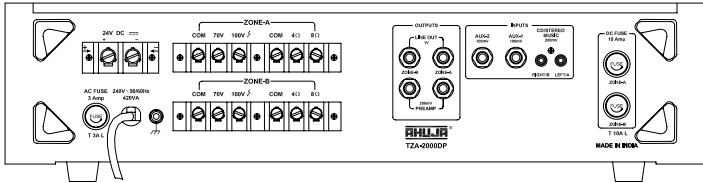

TZA-2000®DP

200 WATTS ■ AC & 24V DC Operation

- 6 Mic, 2 Aux Inputs and CD/Stereo input (L&R)
- Built-in MP3 player with remote control for USB, SD/MMC card reader.
- Bluetooth facility.
- TZA-2000DP is ideal for medium sized installations such as in places of worship where two separate groups of speakers are needed to be connected.
- User has a choice to connect both the zones to 100V (LMT) type speakers, or 100V speakers to one zone and low impedance type speakers to the other zone. Both the zones can also be connected to low impedance type speakers.
- Easy accessibility of DC fuses fitted on rear panel.
- Instant transfer to DC power (Car Battery) if AC power fails.

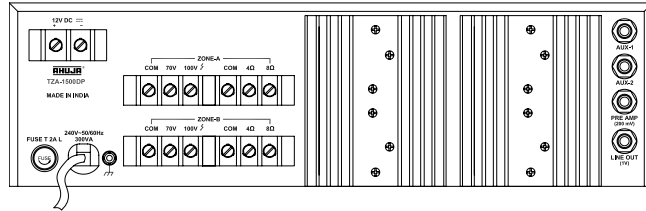

TZA-1500DP

160 WATTS ■ AC & 12V DC Operation

- 6 Mic, 2 Aux Inputs.
- Built-in MP3 player with remote control for USB, SD/MMC card reader.
- Bluetooth facility.
- Preamplifier and Line Output for connecting to a Booster Amplifier and for recording the programme.
- TZA-1500DP is ideal for medium sized installations such as in places of worship where two separate groups of speakers are needed to be connected.
- User has a choice to connect both the zones to 100V (LMT) type speakers, or 100V speakers to one zone and low impedance type speakers to the other zone. Both the zones can also be connected to low impedance type speakers.
- Instant transfer to DC power (Car Battery) if AC power fails.

SPECIFICATIONS

SPECIFICATIONS	TZA-2000®DP	TZA-1500DP
POWER OUTPUT	130W + 130W Max., 100W + 100W RMS at 10% THD 90W + 90W RMS at 5% THD, 80W + 80W RMS at 2% THD	100W + 100W Max., 80W + 80W RMS at 10% THD 70W + 70W RMS at 5% THD, 60W + 60W RMS at 2% THD
OUTPUT REGULATION	≤ 2 dB, no load to full load at 1kHz	≤ 2 dB, no load to full load at 1kHz
INPUT CHANNELS	Mono: 6 × Mic 0.65mV/4.7kΩ, 2 × Aux 100mV/470kΩ Stereo: L/R 250mV/47kΩ	6 × Mic 0.6mV/4.7kΩ, 2 × Aux 100mV/470kΩ —
FREQUENCY RESPONSE	50-15,000Hz ±3dB	65-15,000Hz ±3dB
SIGNAL TO NOISE RATIO	60dB	60dB
TONE CONTROLS	Bass: ±10dB at 100Hz, Treble: ±10dB at 10kHz	Bass: -10dB at 100Hz, Treble: -10dB at 10kHz
OUTPUT	Preamp 200mV/600Ω, Line 1V/1kΩ	Preamp 200mV/600Ω, Line 1V/1kΩ
SPEAKER OUTPUT	4Ω, 8Ω, 70V & 100V for each zone	4Ω, 8Ω, 70V & 100V for each zone
DIGITAL PLAYER	MP3 Player with USB, SD and MMC Card Reader, Bluetooth	MP3 Player with USB, SD and MMC Card Reader, Bluetooth
POWER SUPPLY	AC: 220-240V 50/60Hz DC: 24V (2 × 12V Car Battery)	AC: 220-240V 50/60Hz DC: 12V (12V Car Battery)
POWER CONSUMPTION	AC: 420VA DC: 6.5A	AC: 300VA DC: 6A
DIMENSIONS	W500 × H140 × D345 mm	W460 × H155 × D310 mm
WEIGHT	17.50kg	14.50kg

PA Mixer Amplifiers with Digital Player

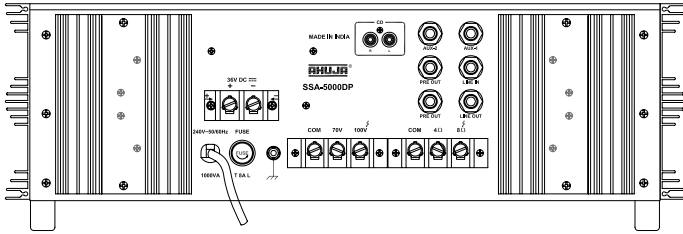

SSA-5000®DP

500 WATTS ■ AC & 36V DC Operation

- 7 Mic & 2 Aux Inputs. With Built-in MP3 player.
- Preamplifier and Line Output for connecting to a Booster Amplifier.
- Bluetooth facility.
- Line Input for connecting the output from any external PA Mixer or another amplifier.
- Resettable circuit breaker for protection against overload and short circuit.
- Instant transfer to DC power (Car Battery) if AC power fails.
- Box Speaker/Driver Unit selector switch. Bass boost defeated at Driver Unit position for safer operation of driver units.

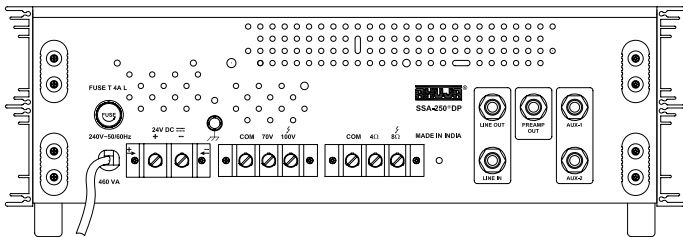

SSA-250®DP

250 WATTS ■ AC & 24V DC Operation

- 6 Mic & 2 Aux Inputs. With Built-in MP3 player.
- Bluetooth facility.
- Preamplifier and Line Output for connecting to a Booster Amplifier and for recording the programme.
- Line Input for connecting the output from any external PA Mixer or another Amplifier.
- Resettable circuit breaker for protection against overload and short circuit.
- Instant transfer to DC power (Car Battery) if AC power fails.
- Box Speaker/Driver Unit selector switch. Bass boost defeated at Driver Unit position for safer operation of driver units.

SPECIFICATIONS

	SSA-5000®DP	SSA-250®DP
POWER OUTPUT	750W Max., 500W RMS at 10% THD 450W RMS at 5% THD, 415W RMS at 2% THD	300W Max., 250W RMS at 10% THD 220W RMS at 5% THD, 200W RMS at 2% THD
OUTPUT REGULATION	≤ 2 dB, no load to full load at 1kHz	≤ 2 dB, no load to full load at 1kHz
INPUT CHANNELS	7 × Mic 0.8mV/4.7kΩ, 2 × Aux 100mV/470 kΩ, 1 × CD 200mV/50 kΩ, 1 × Line 1V/50kΩ	6 × Mic 0.65mV/4.7kΩ, 2 × Aux 100mV/470 kΩ, 1 × Line 1V/50kΩ
FREQUENCY RESPONSE	50-15,000Hz ±3dB	50-15,000Hz ±3dB
SIGNAL TO NOISE RATIO	60dB	60dB
TONE CONTROLS	Bass: ±10dB at 100Hz, Treble: ±10dB at 10kHz	Bass: ±10dB at 100Hz, Treble: ±10dB at 10kHz
OUTPUT	Preamp 200mV/600Ω, Line 1V/1kΩ	Preamp 200mV/600Ω, Line 1V/1kΩ
SPEAKER OUTPUT	4Ω, 8Ω, 70V & 100V	4Ω, 8Ω, 70V & 100V
DIGITAL PLAYER	MP3 Player with USB, SD and MMC Card Reader, Bluetooth	MP3 Player with USB, SD and MMC Card Reader, Bluetooth
POWER SUPPLY	AC: 220-240V 50/60Hz, DC: 36V (3 × 12V Car Battery)	AC: 220-240V 50/60Hz, DC: 24V (2 × 12V Car Battery)
POWER CONSUMPTION	AC: 1000VA DC: 8A	AC: 460VA DC: 6A
DIMENSIONS	W510 × H172 × D385 mm	W450 × H160 × D340 mm
WEIGHT	27.00kg	16.00kg

PA Mixer Amplifiers with Digital Player

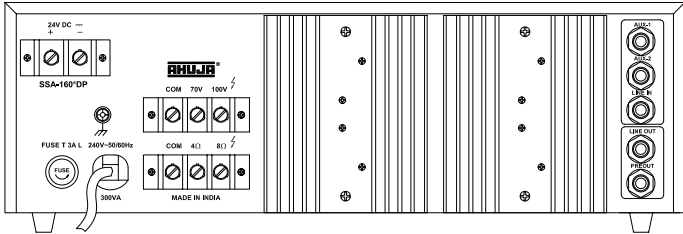

SSA-160® DP

160 WATTS ■ AC & 24V DC Operation

- 5 Mic & 2 Aux Inputs. With Built-in MP3 player.
- Bluetooth facility.
- Pre-amplifier and Line Output for connecting to a Booster Amplifier and for recording the programme.
- Line Input for connecting the output from any external PA Mixer or another Amplifier.
- Resettable circuit breaker for protection against overload and short circuit.
- Instant transfer to DC power (Car Battery) if AC power fails.
- Box Speaker/Driver Unit selector switch. Bass boost defeated at Driver Unit position for safer operation of driver units.
- 5 LED array for output level monitoring.

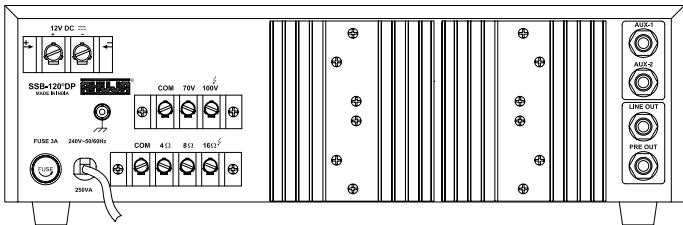

SSB-120® DP

120 WATTS ■ AC & 12V DC Operation

- 5 Mic & 2 Aux Inputs.
- Built-in MP3 player with remote control for USB, SD/MMC card reader.
- Bluetooth facility.
- Line output for connecting to a Booster Amplifier and Pre-amplifier Output for recording the programme.
- Cut and Boost type Bass & Treble controls.
- Instant transfer to DC power (Car Battery) if AC power fails.
- 5 LED array for output level monitoring.

SPECIFICATIONS

SPECIFICATIONS	SSA-160® DP	SSB-120® DP
POWER OUTPUT	220W Max., 160W RMS at 10% THD 140W RMS at 5% THD, 120W RMS at 2% THD	160W Max., 120W RMS at 10% THD 105W RMS at 5% THD, 95W RMS at 2% THD
OUTPUT REGULATION	≤ 2 dB, no load to full load at 1kHz	≤ 2 dB, no load to full load at 1kHz
INPUT CHANNELS	5 × Mic 0.65mV/4.7kΩ, 2 × Aux 100mV/470 kΩ, 1 × Line 1V/50kΩ	5 × Mic 0.65mV/4.7kΩ, 2 × Aux 100mV/470 kΩ
FREQUENCY RESPONSE	50-15,000Hz ±3dB	50-15,000Hz ±3dB
SIGNAL TO NOISE RATIO	60dB	60dB
TONE CONTROLS	Bass: ±10dB at 100Hz, Treble: ±10dB at 10kHz	Bass: ±8dB at 100Hz, Treble: ±8dB at 10kHz
OUTPUT	Preamp 200mV/600Ω, Line 1V/1kΩ	Preamp 200mV/600Ω, Line 1V/1kΩ
SPEAKER OUTPUT	4Ω, 8Ω, 70V & 100V	4Ω, 8Ω, 16Ω, 70V & 100V
DIGITAL PLAYER	MP3 Player with USB, SD and MMC Card Reader, Bluetooth	MP3 Player with USB, SD & MMC Card Reader, Bluetooth
POWER SUPPLY	AC: 220-240V 50/60Hz, DC: 24V (2×12V Car Battery)	AC: 220-240V 50/60Hz, DC: 12V (12V Car Battery)
POWER CONSUMPTION	AC: 300VA DC: 4A	AC: 250VA DC: 5.5A
DIMENSIONS	W426 × H155 × D325 mm	W420 × H135 × D275 mm
WEIGHT	13.30kg	10.30kg

PA Mixer Amplifiers with Digital Player

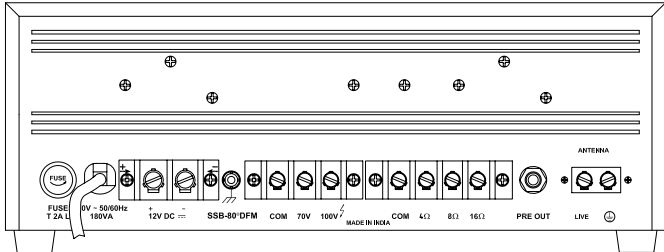

SSB-80®DFM

80 WATTS ■ AC & 12V DC Operation

- 3 Mic & 1 Aux Inputs.
- Built-in MP3 player with remote control for USB, SD/MMC card reader.
- Bluetooth and FM facility.
- Preamplifier Output for connecting to a Booster Amplifier and for recording the programme.
- Cut & Boost type Bass & Treble controls.
- Instant transfer to DC power (Car Battery) if AC power fails.

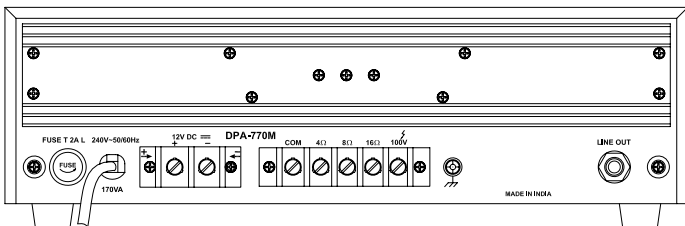

DPA-770®M

75 WATTS ■ AC & 12V DC Operation

- 4 Mic & 1 Aux Input.
- Built-in MP3 player with USB reader and remote control.
- Bluetooth facility.
- Line Output for connecting to a Booster Amplifier.
- Cut and Boost type Bass & Treble controls.
- Instant transfer to DC Power (Car Battery) if AC power fails.

SPECIFICATIONS

	SSB-80®DFM	DPA-770®M
POWER OUTPUT	110W Max., 80W RMS at 10% THD 75W RMS at 5% THD, 60W RMS at 2% THD	100W Max., 75W RMS at 10% THD 70W RMS at 5% THD
OUTPUT REGULATION	≤ 2 dB, no load to full load at 1kHz	≤ 2 dB, no load to full load at 1kHz
INPUT CHANNELS	3 × Mic 1mV/4.7kΩ, 1 × Aux 100mV/470 kΩ	4 × Mic. 0.6mV/4.7kΩ, 1 × Aux 100mV/330kΩ
FREQUENCY RESPONSE	65-15,000Hz ±3dB	50-15,000Hz ±3dB
SIGNAL TO NOISE RATIO	60dB	55dB
TONE CONTROLS	Bass: ±8dB at 100Hz, Treble: ±8dB at 10kHz	Bass: -10dB +7dB at 100Hz, Treble: -10dB +7dB at 10kHz
OUTPUTS	Preamp: 200mV/600Ω	Line: 1V/3.5kΩ
SPEAKER OUTPUTS	4Ω, 8Ω, 16Ω, 70V & 100V	4Ω, 8Ω, 16Ω & 100V
DIGITAL PLAYER	MP3 Player with USB, SD & MMC Card Reader, Bluetooth & FM	MP3 Player with USB, SD, MMC Card Reader & Bluetooth
POWER SUPPLY	AC: 220-240V 50/60Hz, DC: 12V (12V Car Battery)	AC: 220-240V 50/60Hz, DC: 12V (12V Car Battery)
POWER CONSUMPTION	AC: 180VA DC: 3A	AC: 170VA DC: 3A
DIMENSIONS	W355 × H133 × D285 mm	W385 × H125 × D300 mm
WEIGHT	8.43kg	8.80kg

PA Mixer Amplifiers with Digital Player

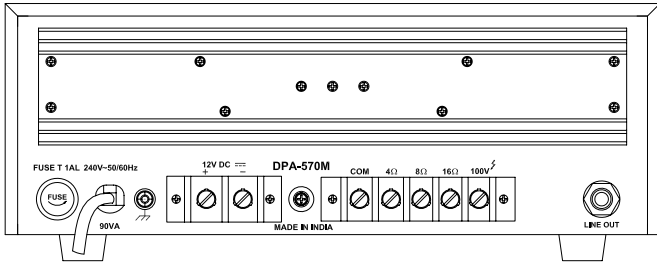

DPA-570®M

50 WATTS ■ AC & 12V DC Operation

- 3 Mic & 1 Aux Input.
- Built-in MP3 player with USB reader and remote control.
- Bluetooth facility.
- Line Output for connecting to a Booster Amplifier.
- Cut and Boost type Bass & Treble controls.
- Instant transfer to DC Power (Car Battery) if AC power fails.

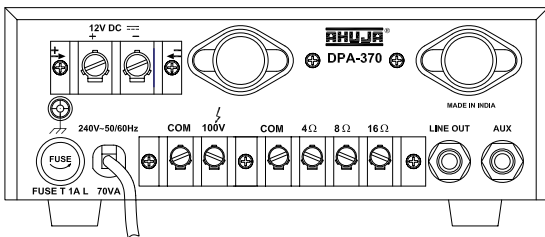

DPA-370®

30 WATTS ■ AC & 12V DC Operation

- 2 Mic & 1 Aux Input.
- Built-in MP3 player with USB reader and remote control.
- Line Output for connecting to a Booster Amplifier.
- Cut type tone control.
- Instant transfer to DC Power (Car Battery) if AC power fails.

SPECIFICATIONS

	DPA-570®M	DPA-370®
POWER OUTPUT	75W Max., 50W RMS at 10% THD, 45W RMS at 5% THD	37W Max., 30W RMS at 10% THD, 27W RMS at 5% THD
OUTPUT REGULATION	≤ 2 dB, no load to full load at 1kHz	≤ 2 dB, no load to full load at 1kHz
INPUT CHANNELS	3 × Mic 0.6mV/4.7kΩ, 1 × Aux 100mV/330kΩ	2 × Mic. 0.5mV/2.5kΩ, 1 × Aux 50mV/330kΩ
FREQUENCY RESPONSE	50-15,000Hz ±3dB	100-12,000Hz ±3dB
SIGNAL TO NOISE RATIO	55dB	58dB
TONE CONTROLS	Bass: ±10dB at 100Hz, Treble: ±10dB at 10kHz	Tone: -10dB at 10kHz
OUTPUTS	Line: 400mV/3.5kΩ	Line: 250mV/3.5kΩ
SPEAKER OUTPUTS	4Ω, 8Ω, 16Ω & 100V	4Ω, 8Ω, 16Ω & 100V
DIGITAL PLAYER	MP3 Player with USB, SD, MMC Card Reader & Bluetooth	MP3 Player with USB reader
POWER SUPPLY	AC: 220-240V 50/60Hz, DC: 12V (12V Car Battery)	AC: 220-240V 50/60Hz, DC: 12V (12V Car Battery)
POWER CONSUMPTION	AC: 90VA DC: 3.1A	AC: 70VA DC: 2.7A
DIMENSIONS	W305 × H120 × D305 mm	W230 × H95 × D285 mm
WEIGHT	6.20kg	4.50kg

PA Mixer Amplifiers with Digital Player

5050-DP

50+50 WATTS ■ AC Operation

- 2 Mic & 1 Aux Inputs.
- Built-in MP3 player with remote control for USB, SD/MMC card reader.
- Bluetooth facility.
- Preamp output for connecting to another Amplifier and for recording the programme.
- Headphone output for monitoring the programmes.
- Cut and Boost type Bass & Treble controls.
- Dual 5 LED array for output level monitoring.

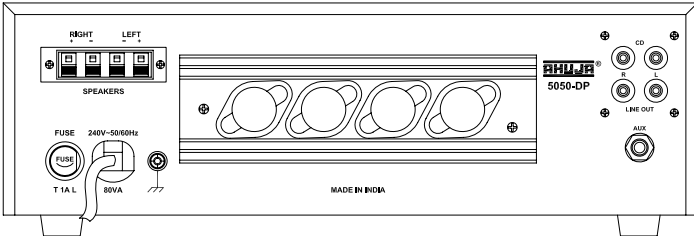

SPECIFICATIONS

5050-DP

POWER OUTPUT	50W + 50W Max., 40W + 40W RMS at 10% THD, 35W + 35W RMS at 1% THD
OUTPUT REGULATION	≤ 2 dB, no load to full load at 1kHz
INPUT CHANNELS	2 × Mic 0.65mV/4.7kΩ, 1 × Aux 100mV/330 kΩ, CD L&R : 200mV/300kΩ
FREQUENCY RESPONSE	20-20,000Hz ±3dB
SIGNAL TO NOISE RATIO	60dB
TONE CONTROLS	Bass: ±10dB at 100Hz, Treble: ±10dB at 10kHz
OUTPUTS	Preamp 200mV/600Ω
SPEAKER OUTPUTS	4Ω to 16Ω (8Ω recommended)
DIGITAL PLAYER	MP3 Player with USB, SD & MMC Card Reader, Bluetooth
POWER SUPPLY	AC: 220-240V 50/60Hz
POWER CONSUMPTION	AC: 80VA
DIMENSIONS	W365 × H125 × D295 mm
WEIGHT	6.40kg



Hallmark of Reliability!



Intelligent Paging Systems

Paging Systems are used to address, inform and alert people in public areas as well as inside buildings. Zonal Paging Systems are specially useful as they allow announcements to be made in selected areas only.

AHUJA Zonal Paging Systems are a set of reliable, sophisticated, user-friendly products, designed with many innovative safety and convenience features for a wide range of applications.

Applications

Shopping Malls | Schools & Colleges | Hotels | Multistorey Buildings

Offices | Factories | Railway Stations | Airports | Hospitals

APM-201RM

Remote Paging Microphone



A high performance 12 zone paging console housed in an elegant aluminium housing. It works with APM-202CU to make a 6 or 12 zone zonal paging system.

- 12 Zone Paging Mic Console with a 400mm (16") gooseneck.
- 12 Zone Selector Switches, plus ALL CALL switch
- Separate Mic ON/OFF switch.
- LED indication of zone selection.
- RESET switch to reset all zone selections.
- Group selection facility.
- Built-in chime circuit.
- Chime & Mic level controls.
- Secure 8 pin lockable connectors.
- Can be used with one APM-202CU to make a 6 zone paging system, or with two nos APM-202CU to make a 12 zone paging system.
- Operates on 24V DC supply from APM-202CU.

SPECIFICATIONS	APM-201RM
OUTPUT LEVEL	1V Balanced (nominal).
SWITCHES	12 Zone Selectors, All Call, Chime, Group 1, Group 2, Mic ON/OFF, Reset
CONTROLS	Mic level, chime level
POWER SUPPLY	DC 24V (from APM-202CU)
DIMENSIONS	W285 × H530 × D160 mm
WEIGHT	1.60kg

APM-202CU Control Unit

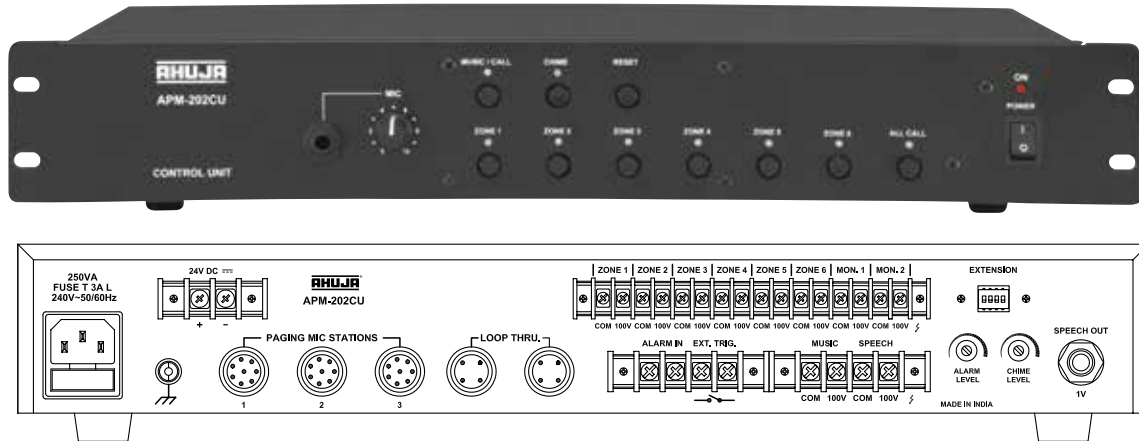

- APM-202CU is a rack mounting switcher / control unit which works with APM-201RM and upto 2 amplifiers to form a 6 zone paging system with multi level priority and switchable background music.
- 6 Zone Switcher / Paging Control Unit for use with APM-201RM.
- 6 Zone Selector switches, plus ALL CALL switch.
- Provision for two 100V input signals, one for speech and one for background music.
- Priority of speech over background music.
- Provision for routing background music source to selected zones.
- Provision to make announcements from the control unit.
- Status monitoring of all zones.
- Provision for emergency trigger input and alarm input with highest priority.
- Standard 19" rack mounting chassis.

SPECIFICATIONS	APM-202CU
SWITCHING SIGNAL LEVEL	100V (Nominal)
INPUTS (Nominal)	3 x APM-201RM (1V/10k balanced), 1 x Mic (1mV/4.7k), Speech Amp (100V), Music Amp (100V), Alarm (100mV).
SWITCHES	6 Zone Selector switches, All Call, Chime, Reset, Music/Call Selector, Power ON/OFF.
CONTROLS	Mic Level, Chime level, Alarm level
POWER SUPPLY	AC 220-240V, 50/60Hz ; DC 24V (2 x 12V Car Battery)
DIMENSIONS	W483 × H75 × D300 mm
WEIGHT	4.80kg

SSW-16M 16 Channel Zone Selector

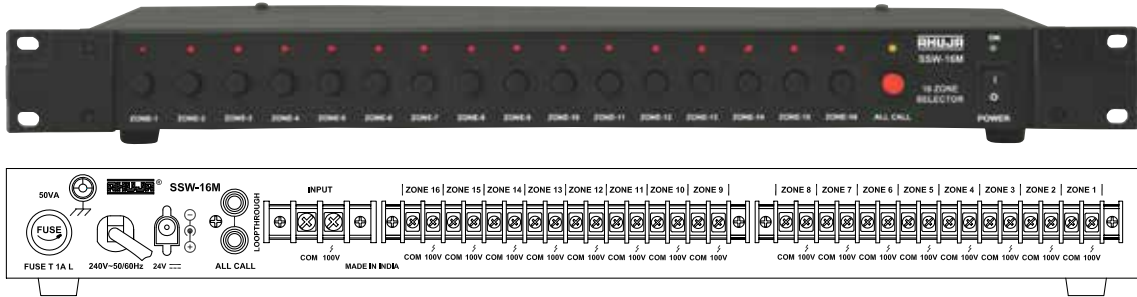

Compact and reliable manual zone selector with provision for switching a 100V audio signal to one or more of upto 16 zones.

- 1 x 100V Input, 16 x 100V Outputs, Manually Switchable.
- When multiple units of SSW-16M are used, ALL CALL activation is possible from any one SSW-16M, by using LOOP THROUGH facility.
- Built-in relay for ALL CALL.
- LED indication of selected zones.

SPECIFICATIONS	SSW-16M
INPUT	1 x 100V (nominal)
OUTPUTS	16 x 100V (nominal)
SWITCHES	16 Zone Selector switches, plus ALL CALL, Power ON/OFF.
POWER SUPPLY	AC 220-240V, 50/60Hz ; DC 24V (2 x 12V Car Battery)
DIMENSIONS	W483 × H53 × D180 mm
WEIGHT	2.73kg



Hallmark of Reliability!



Mixers & Processors

Sophisticated & feature packed !

AHUJA mixers enable effortless management of multi-microphone installations under the most demanding of conditions.

AHUJA provides a wide range of mixers - ranging from small, portable units for field use, to large table top models designed for very large music programmes.

Applications

Concerts | Auditoriums | Live Shows | DJs

PROMIX-1442 AC Operation

With Built-in MP3 Player, 24 Digital Effects, 2 Group Outputs
48V Phantom Supply on all Channels



14 CHANNEL

- Professional mixer with user-friendly construction & aesthetically designed side panels.
- 12 MIC and 10 LINE Balanced Mono inputs with enhanced headroom. 2 STEREO Balanced inputs.
- Built-in MP3 player with 11 preset EQ settings.
- Digital multi EFFECTS processor with 24 built-in effects.
- LCD display for viewing the EFFECTS/USB settings.
- All MIC inputs are through 3 pin F/XLR connectors.
- All LINE & STEREO inputs are through 6.3mm (1/4") stereo phone jack sockets.
- All MIC inputs are available with 48V phantom supply which can be switched ON/OFF.
- Each input channel has a GAIN control, 4 band active EQ controls, AUX1, AUX2, AUX3/EFX, AUX4/FX and PAN control.
- The STEREO channel has a GAIN control, 3 band active EQ control, AUX1, AUX2, AUX3/EFX, AUX4/FX and PAN control.
- PRE/POST selector switch for AUX1 and AUX2 in each channel.
- Channel MUTE switch provided on each individual channel.
- Peak LED for signal clipping indication. Signal LED for input signal indication.
- Balanced Left & Right MAIN Mix outputs through M/XLR connectors as well as 6.3mm (1/4") stereo phone jack sockets.
- Stereo Tape Playback Input through L&R RCA sockets.
- Stereo Tape Output through L&R RCA sockets.
- Two GROUP outputs through 6.3mm (1/4") phone jack sockets and individual group faders.
- Monitor outputs through 6.3mm (1/4") phone jack sockets and individual control.
- Easy and accurate monitoring of Left & Right output levels through individual 12 segment LED array.
- L&R AUX RETURN inputs with level control. PFL switch on each channel.
- Headphone output with Level Control for output monitoring.
- Operates on 240V 50Hz AC mains.

SPECIFICATIONS

PROMIX-1442

MIC INPUT Impedance/Gain	: 2k Ω Balanced/65dB
LINE INPUT Impedance/Gain	: 20k Ω Balanced/45dB
STEREO INPUT (L/Mono & R)	
Impedance/Gain	: 10k Ω Balanced/20dB
THD	: <0.08%
FREQUENCY RESPONSE	: 25Hz - 20kHz (+0, -1dB)
EQUALIZATION	
HI/Hi-Mid/LOW-Mid/LOW	: \pm 12dB at 12kHz/2.5kHz/400Hz/80Hz
CLIP LED INDICATION	: 4 dB prior to true clip
LINE OUTPUT Nominal/Max Level	: 4dBu/21dBu (1.22V/9V)
IMPEDANCE	: 600 Ω
DIGITAL EFFECTS	: 24 Effects Digital Processor
DIGITAL PLAYER	: MP3 Player with USB Reader, 11 Preset EQs
HEADPHONE OUTPUT	: 200mV at 8 Ω , THD <1%

MAXIMUM GAIN	
Mic Input to Line Outputs	: 90dB
Line Input to Line Outputs	: 70dB
Stereo Input to Line Outputs	: 20dB
AUX Send (Pre) Unbalanced	: 5V
AUX Send (Post) Unbalanced	: 9V
AUX Return (L&R) Balanced	: 600mV
GROUP OUTPUTS	: 3V
MONITOR OUTPUTS	: 1.6V
Tape Output (L&R)	: 600mV
Tape Input (L&R)	: 100mV
SIGNAL TO NOISE RATIO	: >80dB
POWER SUPPLY	: AC: 220-240V, 50/60Hz
DIMENSIONS	: W560 \times H111 \times D410 mm
WEIGHT	: 6.70kg

PMX-1632FX AC Operation

With Digital Effects, 48V Phantom Supply on 4 Channels.



16 CHANNEL

- Rugged, stable, high quality analog mixers with user-friendly construction & aesthetically designed side panels.
- 12 MIC/LINE Balanced Mono input channels and 2 STEREO Balanced input channels.
- MIC/LINE Balanced Mono inputs with enhanced headroom.
- All MIC inputs are through 3 pin F/XLR connectors and all LINE & STEREO inputs are through 6.3mm (1/4") stereo phone jack sockets.
- Four MIC inputs (MIC-1 to MIC-4) are available with 48V phantom supply which can be switched ON/OFF through a common switch.
- STEREO Balanced input in two selectable sensitivities of -10dBu & +4dBu.
- Separate EFFECT channel is provided for operating the built-in digital effect processor through a delay selector switch, delay, repeat and level controls.
- Each MIC/LINE channel has a GAIN control, 3 band active Equalizer controls, a Pre-fader AUX1 control, a Post-fader AUX2 /EFX control & a PAN control.
- Each STEREO channel has a GAIN control, 2 band active Equalizer controls, AUX1 Pre fader control, AUX2/EFX Post fader control and a BALANCE control.
- Channel ON/OFF switch provided on each individual channel. Peak LED for signal clipping indication.
- High precision 60mm slide fader on each channel.
- Balanced Left & Right Line outputs through M/XLR connectors as well as 6.3mm (1/4") stereo phone jack sockets.
- Easy and accurate monitoring of Left & Right output levels through individual 12 segment LED array.
- Two AUX SEND outputs with level controls: one each for monitoring and effects processing applications.
- Two stereo AUX RETURN balanced inputs with level controls.
- Headphone output with Level Control for output monitoring.
- Stereo RCA IN/OUT for record and playback.
- Operates on 240V 50Hz AC mains.

SPECIFICATIONS

PMX-1632FX

MIC INPUT		DELAY RANGE SETTINGS	: 1: 60-300ms, 2: 300-500ms, 3: 500-650ms
Impedance/Gain	: 2k Ω Balanced/65dB	HEADPHONE OUTPUT	: 200mV at 8 Ω , THD <1%
LINE INPUT		MAXIMUM GAIN	
Impedance/Gain	: 20k Ω Balanced/45dB	Mic Input to Line Outputs	: 78dB
STEREO INPUT (L/Mono & R)		Line Input to Line Outputs	: 58dB
Impedance/Gain (-10dBu Input)	: 10k Ω Balanced/14dB	Stereo Input to Line Outputs	: 28dB (-10dBu Input)
Impedance/Gain (+4dBu Input)	: 10k Ω Balanced/0dB		: 14dB (+4dBu Input)
THD	: <0.08%	AUX Send (Pre)	: 1.4V/100 Ω Unbalanced
FREQUENCY RESPONSE	: 25Hz - 20kHz (+0, -1dB)	AUX Send (Post)	: 2.7V/100 Ω Unbalanced
EQUALIZATION		AUX Return (L&R)	: 150mV/10k Ω Balanced
Bass/Mid/Treble	: \pm 12dB at 100Hz/2kHz/10kHz	Record Output (L&R)	: 250mV/600 Ω
CLIP LED INDICATION	: 4 dB prior to true clip	Playback Input (L&R)	: 250mV/1k Ω (variable through GAIN control)
LINE OUTPUT		SIGNAL TO NOISE RATIO	: >70dB
Nominal/Max Level	: 4dBu/21dBu (1.22V/9V)	POWER SUPPLY	: AC: 220-240V, 50/60Hz
IMPEDANCE	: 600 Ω	DIMENSIONS	: W609 \times H110 \times D435 mm
DELAY SYSTEM	: Digital Signal Processing	WEIGHT	: 9.80kg

PMX-1032DFX AC Operation

With Built-in MP3 Player, Digital Effects, 48V Phantom Supply on 4 Channels.



10 CHANNEL

PMX-1032FX AC Operation

With Digital Effects, 48V Phantom Supply on 4 Channels.



10 CHANNEL

- Rugged, stable, high quality analog mixers with user-friendly construction & aesthetically designed side panels.
- Both PMX-1032DFX & PMX-1032FX have 8 MIC/LINE Balanced Mono input channels and 1 STEREO Balanced input channel.
- Only PMX-1032DFX has MP3 Player with USB, SD card reader and Bluetooth facility.
- MIC/LINE Balanced Mono inputs with enhanced headroom.
- All MIC inputs are through 3 pin F/XLR connectors and all LINE & STEREO inputs are through 6.3mm (1/4") stereo phone jack sockets.
- Four MIC inputs (MIC-1 to MIC-4) are available with 48V phantom supply which can be switched ON/OFF through a common switch.
- STEREO Balanced input in two selectable sensitivities of -10dBu & +4dBu.
- Separate EFFECT channel is provided for operating the built-in digital effect processor through delay, repeat and level controls.
- Each MIC/LINE channel has a GAIN control, 3 band active Equalizer controls, a Pre-fader AUX1 control, a Post-fader AUX2 /EFX control & a PAN control.
- Each STEREO channel has a GAIN control, 2 band active Equalizer controls, AUX1 Pre fader control, AUX2/EFX Post fader control and a BALANCE control.
- Channel ON/OFF switch provided on each individual channel. Peak LED for signal clipping indication.
- High precision 60mm slide fader on each channel.
- Balanced Left & Right Line outputs through M/XLR connectors as well as 6.3mm (1/4") stereo phone jack sockets.
- Easy and accurate monitoring of Left & Right output levels through individual 12 segment LED array.
- Two AUX SEND outputs with level controls: one each for monitoring and effects processing applications.
- Two stereo AUX RETURN balanced inputs with level controls.
- Headphone output with Level Control for output monitoring.
- Stereo RCA IN/OUT for record and playback.
- Operates on 240V 50Hz AC mains.

SPECIFICATIONS

MIC INPUT Impedance/Gain	: 2k Ω Balanced/65dB	HEADPHONE OUTPUT	: 200mV at 8 Ω , THD <1%
LINE INPUT Impedance/Gain	: 20k Ω Balanced/45dB	MAXIMUM GAIN	
STEREO INPUT (L/Mono & R)		Mic Input to Line Outputs	: 78dB
Impedance/Gain (-10dBu Input)	: 10k Ω Balanced/14dB	Line Input to Line Outputs	: 58dB
Impedance/Gain (+4dBu Input)	: 10k Ω Balanced/0dB	Stereo Input to Line Outputs	: 28dB (-10dBu Input) 14dB (+4dBu Input)
THD	: <0.08%	AUX Send (Pre)	: 1.4V/100 Ω Unbalanced
FREQUENCY RESPONSE	: 25Hz - 20kHz (+0, -1dB)	AUX Send (Post)	: 2.7V/100 Ω Unbalanced
EQUALIZATION Bass/Mid/Treble	: \pm 12dB at 100Hz/2kHz/10kHz	AUX Return (L&R)	: 150mV/10k Ω Balanced
CLIP LED INDICATION	: 4 dB prior to true clip	Record Output (L&R)	: 250mV/600 Ω
LINE OUTPUT Nominal/Max Level	: 4dBu/21dBu (1.22V/9V)	Playback Input (L&R)	: 250mV/1k Ω (variable through GAIN control)
IMPEDANCE	: 600 Ω	SIGNAL TO NOISE RATIO	: >70dB
DELAY SYSTEM	: Digital Signal Processing	POWER SUPPLY	: AC: 220-240V, 50/60Hz
DELAY RANGE SETTINGS		DIMENSIONS (PMX-1032DFX)	: W465 \times H110 \times D435 mm
PMX-1032DFX	: Variable from 30 to 400ms	DIMENSIONS (PMX-1032FX)	: W465 \times H110 \times D435 mm
PMX-1032FX	: 1: 60-300ms, 2: 300-500ms, 3: 500-650ms	WEIGHT (PMX-1032DFX)	: 7.70kg
DIGITAL PLAYER		WEIGHT (PMX-1032FX)	: 7.70kg
PMX-1032DFX	: MP3 Player with USB, SD and MMC Card Reader		



14 CHANNEL

AMX-1412 AC & 24V DC Operation

- Each Channel has separate 6.3mm (1/4") balanced phone jack for Mic and Line & accepts both balanced & unbalanced signals.
- AUX Send & AUX Return : These have been provided for sending the pre-fader output of channels for monitoring or for adding a Special Effects Unit.
- MONO/STEREO Output : Mono output is available from either Left & Right output jacks when the switch is in 'Mono' position.
- Each channel has GAIN, BASS, MID, TREBLE, ECHO, PAN and slide LEVEL controls with CLIP LED indicator.
- Echo section provided with Delay, Repeat & Level controls.
- Stereo RCA IN/OUT for record and playback.
- Headphone output, with volume control, for monitoring purposes.



8 CHANNEL

AMX-812 AC & 24V DC Operation

- Each Channel has a 6.3mm (1/4") phone jack selectable for either Mic or Line input & accepts both balanced & unbalanced signals.
- Independent Stereo input through separate 1/4" unbalanced phone jacks for Left & Right channels.
- Each channel has GAIN, BASS, TREBLE, PAN, ECHO and LEVEL controls with Clip LED indicator.
- Echo section provided with Delay, Repeat & Level controls.
- Stereo RCA IN/OUT for record and playback.
- Headphone output, with volume control, for monitoring purposes.

SPECIFICATIONS	AMX-1412	AMX-812
MIC INPUT (IMPEDANCE/GAIN)	2k Ω Balanced/62dB, 1k Ω Unbalanced/62dB	2k Ω Balanced/62dB, 1k Ω Unbalanced/62dB
LINE INPUT (IMPEDANCE/GAIN)	20k Ω Balanced/42dB, 10k Ω Unbalanced/42dB	20k Ω Balanced/42dB, 10k Ω Unbalanced/42dB
DISTORTION	< 0.08%	< 0.08%
FREQUENCY RESPONSE	30Hz - 20kHz (+0, -1dB)	30Hz - 20kHz (+0, -1dB)
TONE CONTROLS	Bass : \pm 12dB at 100Hz, Mid : \pm 12dB at 2kHz, Treble : \pm 12dB at 10kHz	Bass : \pm 12dB at 100Hz, Treble : \pm 12dB at 10kHz
OUTPUT		
LINE OUTPUT LO	-10dBu/+2dBu (200mV/1V)	—
LINE OUTPUT HI	0dBu/+17dBu (775mV/5.5V)	0dBu/+17dBu (775mV/5.5V)
ECHO/REVERB SYSTEM	Digital Signal Processing	Digital Signal Processing
SIGNAL TO NOISE RATIO	>70dB (0dBm, 0.775V)	>70dB (0dBm, 0.775V)
POWER SUPPLY	AC: 220-240V 50/60Hz, DC: 24V (2 \times 12V Car Battery)	AC: 220-240V 50/60Hz, DC: 24V (2 \times 12V Car Battery)
DIMENSIONS	W633 \times H93 \times D420 mm	W423 \times H93 \times D302 mm
WEIGHT	9.40kg	5.10kg



9 CHANNEL

AMX-912DP AC & 24V DC Operation

With built-in MP3 Player & Digital Effects

- Input Channels: Each Channel has separate 6.3mm (1/4") balanced phone jack for Mic & Line which accepts both balanced & unbalanced signals.
- USB Playback: Built-in MP3 Player selectable through Channel 9/USB Switch and controllable through an independent USB input volume control. Channel 9 can be used for Mic & Line inputs or USB Playback function.
- Bluetooth facility.
- MONO/STEREO Output: Mono output is available from Left & Right output jacks when the switch is in 'Mono' position.
- Each channel has GAIN, BASS, TREBLE, ECHO, PAN and slide LEVEL controls with CLIP LED indicator.
- Echo section provided with Delay, Repeat & Level controls.
- Stereo RCA IN/OUT for record and playback.
- Headphone output with Level Control for output monitoring.



9 CHANNEL

AMX-912 AC & 24V DC Operation

- Each Channel has separate 6.3mm (1/4") balanced phone jack for Mic & Line & accepts both balanced & unbalanced signals.
- MONO/STEREO Output: Mono output is available from Left & Right output jacks when the switch is in 'Mono' position.
- Each channel has GAIN, BASS, TREBLE, ECHO, PAN and slide LEVEL controls with CLIP LED indicator.
- Echo section provided with Delay, Repeat & Level controls.
- Stereo RCA IN/OUT for record and playback.
- Headphone output, with volume control, for monitoring purposes.

SPECIFICATIONS	AMX-912DP	AMX-912
MIC INPUT (IMPEDANCE/GAIN)	2k Ω Balanced/62dB, 1k Ω Unbalanced/62dB	2k Ω Balanced/62dB, 1k Ω Unbalanced/62dB
LINE INPUT (IMPEDANCE/GAIN)	20k Ω Balanced/42dB, 10k Ω Unbalanced/42dB	20k Ω Balanced/42dB, 10k Ω Unbalanced/42dB
DISTORTION	< 0.08%	< 0.08%
FREQUENCY RESPONSE	30Hz - 20kHz (+0, -1dB)	30Hz - 20kHz (+0, -1dB)
TONE CONTROLS	Bass : \pm 12dB at 100Hz, Treble : \pm 12dB at 10kHz	Bass : \pm 12dB at 100Hz, Treble : \pm 12dB at 10kHz
OUTPUT	LINE OUTPUT LO	-10dBu/+2dBu (200mV/1V)
	LINE OUTPUT HI	0dBu/+17dBu (775mV/5.5V)
DELAY SYSTEM	Digital Signal Processing	Digital Signal Processing
DELAY RANGE SETTINGS	Variable from 30 to 400ms	Variable from 30 to 400ms
DIGITAL PLAYER	MP3 Player with USB, SD and MMC Card Reader, Bluetooth	—
SIGNAL TO NOISE RATIO	>70dB (0dBm, 0.775V)	>70dB (0dBm, 0.775V)
POWER SUPPLY	AC: 220-240V 50/60Hz, DC: 24V (2 \times 12V Car Battery)	AC: 220-240V 50/60Hz, DC: 24V (2 \times 12V Car Battery)
DIMENSIONS	W483 \times H93 \times D366 mm	W483 \times H93 \times D366 mm
WEIGHT	6.90kg	6.90kg



6 CHANNEL

FMX-106DP AC Operation

With built-in MP3 Player & Digital Effects



- Compact and reliable professional PA Mixer which is aesthetically superior and easily portable.
- Upto four low impedance microphones and Line level signal sources can be connected in either balanced or unbalanced configuration, through a 6.3 mm (1/4") stereo jack socket.
- Each channel has a GAIN control for optimum adjustment of the MIC & LINE input sensitivities.
- Active BASS & TREBLE controls in each channel for desired equalisation of the input signal.
- Separate FX (effects) level control for each input channel.
- MP3 digital player with recording, playback through USB & Bluetooth facility.
- Stereo input channel is provided with a GAIN control, 2 band EQ, FX & LEVEL Controls.
- Built-in digital effects processor with DELAY, REPEAT and LEVEL controls.
- Line level LEFT & RIGHT outputs through 6.3 mm (1/4") stereo jack sockets. Individual SIGNAL & CLIP LEDs for optimum setting of signal levels.



6 CHANNEL

FMX-106 AC Operation



- Compact and reliable professional PA Mixer which is aesthetically superior and easily portable.
- Upto four low impedance microphones and Line level signal sources can be connected in either balanced or unbalanced configuration, through a 6.3 mm (1/4") stereo jack socket.
- Each channel has a GAIN control for optimum adjustment of the MIC & LINE input sensitivities.
- Active BASS & TREBLE controls in each channel for desired equalisation of the input signal.
- Separate FX (effects) level control for each input channel.
- Stereo input channel is provided with a GAIN control, 2 band EQ, FX & LEVEL Controls.
- Built-in digital effects processor with DELAY, REPEAT and LEVEL controls.
- Line level LEFT & RIGHT outputs through 6.3 mm (1/4") stereo jack sockets. Individual SIGNAL & CLIP LEDs for optimum setting of signal levels.

SPECIFICATIONS	FMX-106DP	FMX-106
MIC INPUT (IMPEDANCE/GAIN)	2k Ω Balanced/65dB, 1k Ω Unbalanced/65dB	2k Ω Balanced/65dB, 1k Ω Unbalanced/65dB
LINE INPUT (IMPEDANCE/GAIN)	20k Ω Balanced/45dB, 10k Ω Unbalanced/45dB	20k Ω Balanced/45dB, 10k Ω Unbalanced/45dB
DISTORTION	< 0.1%	< 0.1%
FREQUENCY RESPONSE	25Hz-20 kHz (-1dB)	25Hz-20 kHz (-1dB)
TONE CONTROLS	Bass: \pm 15dB at 80Hz, Treble: \pm 15dB at 12kHz	Bass: \pm 15dB at 80Hz, Treble: \pm 15dB at 12kHz
LINE OUTPUT	0dBu/+21dBu (775mV/9V)	0dBu / +21dBu (775mV/9V)
DELAY SYSTEM	Digital Signal Processing	Digital Signal Processing
DELAY RANGE SETTINGS	Variable from 20 to 300ms	Variable from 20 to 300ms
DIGITAL PLAYER	MP3 Player/Recorder with USB Reader, Bluetooth	—
SIGNAL TO NOISE RATIO	> 68dB	> 68dB
POWER SUPPLY	AC: 220-240V 50/60Hz	AC: 220-240V 50/60Hz
DIMENSIONS	W281 x H75 x D210 mm	W281 x H75 x D210 mm
WEIGHT	1.60kg	1.60kg



MMX-55

AC & 12V DC Operation

Compact General Purpose 5 Channel PA Mixer Preamplifier

- 5 Mic/Aux inputs with individual volume controls.
- Selectable HI/LO sensitivity for AUX inputs.
- Compact and easy to use.
- Peak LED for setting distortion-free input levels.

MX-15

AC & 12V DC Operation

General Purpose 12 Channel PA Mixer Preamplifier

- 9 Mic inputs; each with an On/Off switch and LED indicator. 3 Mic/Aux inputs.
- Master control for overall adjustment.
- 4 Line outputs for connecting a number of Amplifiers or Boosters. Headphone output for monitoring.
- Active Bass and Treble tone controls.

SPECIFICATIONS	MMX-55	MX-15
OUTPUTS	1 × Preamp 200mV/600Ω	2 × Preamp 200mV/600Ω, 4 × Line 1V/1kΩ, 1 × Headphone 120mV@ 8Ω
FREQUENCY RESPONSE	20-20,000Hz (±3dB)	20-20,000Hz (±3dB)
DISTORTION	< 1%	< 1%
SIGNAL TO NOISE RATIO	40dB	50dB
INPUT CHANNELS	5 × Mic 0.6mV/4.7kΩ, 5 × Aux LO 50mV/470kΩ; Aux HI 150mV/470kΩ (Mic/Aux LO/ Aux HI switchable)	12 × Mic 0.6mV/4.7kΩ, 2 × Aux 100mV/470kΩ, 1 × Aux 500mV/100kΩ
TONE CONTROLS	—	Bass: ± 10dB at 100Hz, Treble: ± 10dB at 10kHz
POWER SUPPLY	AC: 220-240V 50/60Hz, DC: 12V (1×12V Car Battery)	AC: 220-240V 50/60Hz, DC: 12V (1×12V Car Battery)
DIMENSIONS	W215 × H60 × D125 mm	W355 × H145 × D215 mm
WEIGHT	1.20kg	3.70kg

DJ Mixer



ADJ-300

AC Operation

- Rugged, reliable and easy to operate 3-channel DJ mixer.
- Three MIC inputs alternate to three stereo LINE/CD inputs.
- MIC-1 is balanced XLR input with TALKOVER priority.
- Each channel has a GAIN control, 3 band active EQ, MIC-LINE selector switch, CUE ON/OFF switch and channel fader control.
- Ultra smooth slide control for CROSSFADER function.
- Slide switch for selecting the desired crossfade curve i.e. Flat or Steep.
- Master, Booth and Rec stereo outputs through RCA socket.
- Mono Subwoofer output with two frequencies of 120 & 180Hz.
- Stereo headphone output with CUE volume control.
- CUE MIX switch for selecting between BLEND & SPLIT function.
- Independent controls for MASTER, BOOTH, SUB and CUE outputs.
- Individual 12 segment LED array for indicating L & R output levels.

SPECIFICATIONS	ADJ-300
MIC INPUTS	2mV/4.7kΩ
LINE INPUTS (L & R)	100mV/10kΩ
DISTORTION	< 0.08%
FREQUENCY RESPONSE	20Hz - 22kHz (-3dB)
TONE CONTROLS	Bass : -30dB / +15dB at 100Hz, Mid : -30dB / +15dB at 1kHz, Treble : -30dB / +15dB at 10kHz
OUTPUTS (NOMINAL)	MASTER: 1V (BAL), BOOTH: 1V (UNBAL), RECORD: 500mV (UNBAL), SUBOUT (Mono): 1V (BAL), Headphones: 200mV@ 8Ω
SUB CROSSOVER FREQUENCIES	120Hz and 180Hz (Selectable)
SIGNAL TO NOISE RATIO	>80dB
CROSSTALK	< 65dB
TALKOVER	-15dB attenuation
POWER SUPPLY	AC: 220-240V 50/60Hz
DIMENSIONS	W260 × H125 × D310 mm
WEIGHT	4.35kg

Automatic Feedback Terminator

AFT-24F2M AC Operation



AFT-24F2M is a dual channel automatic feedback suppression unit. This feature packed PA Signal Processor is designed to provide fast and accurate feedback control in fixed installations as well as live shows.

- 24 digital notch filters and LED indicators for each channel.
- Electronically balanced inputs and outputs available through XLR connectors as well as 6.3mm (1/4") stereo phone sockets.
- Each channel has a MODE switch for selecting the filter width between 1/80th octave (for music applications) and 1/5th octave (for speech applications).
- Each channel has separate push switch for choosing between LIVE and SETUP mode.
- The notch filters can be defeated through BYPASS push switch which is available for each channel.
- Provision of a Lock switch on rear panel enables the user to keep its settings intact during a program.
- Four segment LED indicator and a Clip LED for each channel.

SPECIFICATIONS	AFT-24F2M
INPUT IMPEDANCE	5.6k Ω Balanced/2.7k Ω Unbalanced
MAX INPUT LINE LEVEL	+15dBu
OUTPUT IMPEDANCE	100 Ω Balanced/50 Ω Unbalanced
MAX OUTPUT LEVEL	+15dBu
A/D CONVERSION	24 bit
SAMPLING RATE	48kHz
SIGNAL TO NOISE RATIO	106dB
FREQUENCY RESPONSE	20-20,000Hz (-1dB)
POWER SUPPLY	220-240V AC 50/60Hz
DIMENSION	W483 × H45 × D200 mm
WEIGHT	2.40kg

2-Channel 31-Band Graphic Equalizer

AGE-31X2 AC Operation



High quality, professional 2-channel, 31-band graphic equalizer for accurate tuning of the frequency response, and feedback control. Highly effective for enhancing the audio experience of any sound installation. Ideal for a wide variety of PA and Pro Audio applications.

- Two independent 31 band graphic equalizers in 1/3 octave Constant Q frequency bands.
- Switchable cut/boost range of 6dB and 12dB. Low-cut filter ON/OFF switch for each channel.
- Equalizer bypass switch easily accessible on front panel.
- Input control has a gain range from -12dB to +12dB.
- Four segment LED indicator for monitoring output levels and a Clip LED for each channel.
- Accepts line level balanced inputs through XLR as well as 6.3mm (1/4") stereo phone sockets.

SPECIFICATIONS	AGE-31X2
INPUT IMPEDANCE	40k Ω Balanced/20k Ω Unbalanced
MAX INPUT LINE LEVEL	+21dBu
OUTPUT IMPEDANCE	200 Ω Balanced/100 Ω Unbalanced
MAX OUTPUT LEVEL	+20dBu
SIGNAL TO NOISE RATIO	100dB
FREQUENCY RESPONSE	20-20,000Hz (-1dB)
POWER SUPPLY	220-240V AC 50/60Hz
DIMENSION	W483 × H90 × D180 mm
WEIGHT	3.70kg



DMX-44

AC & 12V DC Operation

Professional 4 Channel Mixer Preamplifier with Digital Effects Processor for Echo, Reverb, Chorus Effect

- 3 Selectable delay settings for fine adjustment.
- Compatible with Audio Mixing Consoles.
- Peak LED for setting optimum distortion free input levels.
- Echo facility on all inputs through Echo level, repeat & delay controls.



DMX-22

AC & 12V DC Operation

2 Channel Mixer Preamplifier for Echo, Reverb, Chorus, Effects

- Digital Signal Processing.
- Adds colour to vocal & musical instruments.
- Peak LED for setting optimum distortion free input levels.
- Echo facility on all inputs through Echo volume, repeat & delay controls.

SPECIFICATIONS	DMX-44	DMX-22
OUTPUTS	Preamp: 200mV/680Ω, Line: 775mV/1kΩ	Preamp: 200mV
FREQUENCY RESPONSE	20-20,000Hz (±1dB)	20-20,000Hz (±3dB)
DISTORTION	< 1%	< 1%
SIGNAL TO NOISE RATIO	45dB	40dB
INPUT CHANNELS	4 × Mic 2.5mV/10kΩ, 1 × Aux 250mV/220kΩ	2 × Mic 0.6mV
ECHO REVERB SYSTEM	Digital Signal Processing	Digital Signal Processing
DELAY TIME RANGE	60ms to 300ms, 300ms to 500ms, 500ms to 650ms	20ms to 600ms
POWER SUPPLY	AC: 220-240V 50/60Hz DC: 12V	AC: 220-240V 50/60Hz DC: 12V (1 × 12V Car Battery)
DIMENSIONS	W483 × H53 × D197 mm	W215 × H60 × D125 mm
WEIGHT	2.50kg	1.20kg



Hallmark of Reliability!



Microphones

Microphones are the first and most visible part in most public address systems. Outstanding sound reproduction requires outstanding microphones.

AHUJA offers a wide range of microphones: dynamic and condenser, handheld and lavalier, cabled and wireless.... an outstanding microphone for each & every application.

Applications

Public Meetings | Interviews | Recordings | Presentations | Car Paging

Celebrations | Mobile Announcements | Tourist Coaches | Places of Worship



PRO+ 7500du

LIVE STAGE PERFORMANCE MICROPHONE

PRO+ 7500du is a most elegant and durable Live Stage Performance Microphone with TWO CARTRIDGES for good distance pick-up. High sensitivity and supercardioid pattern makes it ideal for Live Stage Performances, as well as Vocal and Choir applications.

- Built-in dual high sensitivity cartridges for excellent distance pick-up.
- Cartridges are effectively shock mounted to reduce handling noises.
- Slide potentiometer for smooth and noiseless ON/OFF operation.
- Supercardioid polar pattern for obtaining higher gain before feedback.
- Unique hinge design for angle adjustment - forward 30° and backward 45°.
- Rugged zinc die-cast body in classic design.

Mic Type	: Dynamic
Polar Pattern	: Supercardioid
Impedance	: 1.2kΩ
Frequency Response	: 50-15,000Hz
Sensitivity	: 5.0mV/Pa
Switch	: ON/OFF Slide Potentiometer Switch

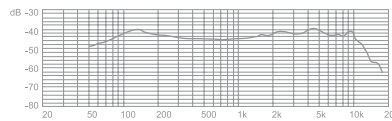

Frequency Response Curve

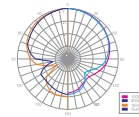

Polar Pattern

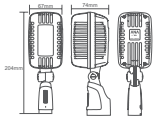

Dimensions

PROFESSIONAL PERFORMANCE SERIES

Supercardioid Dynamic Pro-Entertainment + Studio



Supercardioid Dynamic Pro-Entertainment + Studio



PRO+ 3400

Premium microphone for the most demanding high end applications. Superb shock mount system of the cartridge. Noiseless magnetic reed switch. Ideal for all Vocal and PA applications.

- Frequency Response : 40-16,000Hz
- Sensitivity : 3.15mV/Pa
- Impedance : 350Ω

Supplied with quick detachable holder with 3-pin professional XLR connector & 10m twin core shielded low noise cable.

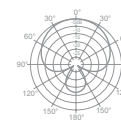
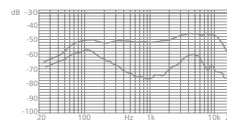

PRO+ 3200

Professional microphone for live vocal, music instruments, studio recording & broadcasting. Superior double shock-mount system and noiseless switch. Exceptionally warm and articulate sound.

- Frequency Response : 50-18,000Hz
- Sensitivity : 2.5mV/Pa
- Impedance : 300Ω

Supplied with quick detachable holder with 3-pin professional XLR connector & 10m twin core shielded low noise cable.

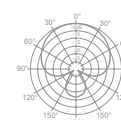
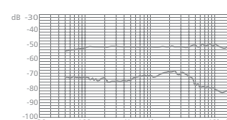

Supercardioid Dynamic Pro-Entertainment



PRO-2200SC

Great performance PA microphone for live vocal & music. Hardened grille with anti-roll rubber ring.

- Frequency Response : 50-18,000Hz
- Sensitivity : 2.1mV/Pa
- Impedance : 300Ω

Supplied with quick detachable holder with 3-pin professional XLR connector & 10m twin core shielded low noise cable.

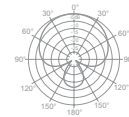
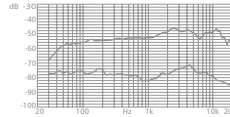

Unidirectional Dynamic Stage Performance



SHM-1000XLR®

Highly sensitive microphone picks up even weak sound from longer distance & wider area. Noiseless magnetic reed switch. Suitable for Dramas, Stage shows, Group singing & Church choir. Smooth frequency response.

- Frequency Response : 50-16,000Hz
- Sensitivity : 1.6mV/Pa
- Impedance : 250Ω

Supplied with quick detachable holder with 3-pin professional XLR connector & 10m twin core shielded low noise cable.

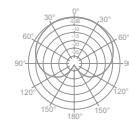
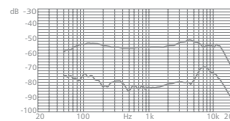

Supercardioid Dynamic Speech & Vocal



DM-740



Highly sensitive cartridge with most natural reproduction. Ideal for live vocal, music and PA applications.

- Frequency Response : 50-15,000Hz
- Sensitivity : 2.5mV/Pa
- Impedance : 600Ω

Supplied with quick detachable microphone holder.

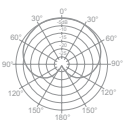
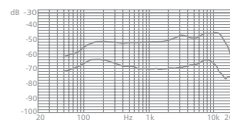

Unidirectional Dynamic Speech & Vocal



DM-440



Intelligible and crisp sound reproduction. Wide frequency response and cardioid pick-up pattern. Ideal for high end speech & music applications.

- Frequency Response : 50-15,000Hz
- Sensitivity : 2.0mV/Pa
- Impedance : 600Ω

Supplied with quick detachable microphone holder.

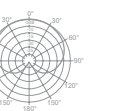
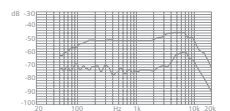

Unidirectional Dynamic Vocal & Speech



ASM-980XLR

Rugged & reliable microphone with superb speech quality and excellent finish. Anti-roll design. Ideal for live vocals and PA applications.

- Frequency Response : 50-16,000Hz
- Sensitivity : 2.0mV/Pa
- Impedance : 300Ω

Supplied with quick detachable holder with 3-pin professional XLR connector & 10m twin core shielded low noise cable.

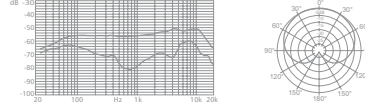

Unidirectional Dynamic Music & Vocal



ASM-780XLR

High output neodymium cartridge, excellent intelligibility & wide frequency response. Ideal for live vocal, music & studio applications.

- Frequency Response : 50-16,000Hz
- Sensitivity : 2.0mV/Pa
- Impedance : 300Ω

Supplied with quick detachable holder with 3-pin professional XLR connector & 10m twin core shielded low noise cable.

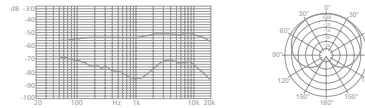

Unidirectional Dynamic Speech & Vocal



ASM-580XLR®

Upper mid-range presence peak for intelligible sound and ideal for close-to-lip singing. Accentuates warmth and clarity.

- Frequency Response : 50-16,000Hz
- Sensitivity : 2.0mV/Pa
- Impedance : 300Ω

Supplied with quick detachable holder with 3-pin professional XLR connector & 10m twin core shielded low noise cable.



GENERAL PA SERIES

Unidirectional Dynamic Multi Purpose Applications



AUD-101XLR®

All purpose PA microphone reproducing intelligible, crisp and a bright sound. Suitable for multi-purpose PA installations.

- Frequency Response : 50-15,000Hz
- Sensitivity : 2.2mV/Pa
- Impedance : 500Ω

Supplied with quick detachable holder with 3-pin professional XLR connector & 6m twin core shielded low noise cable.



Unidirectional Dynamic Multi Purpose Applications



AUD-100XLR

High Output Neodymium cartridge. Rugged and reliable PA microphone with non-reflective finish. Ideal for amateur artistes on stage. Recommended for speech and paging applications.

- Frequency Response : 50-15,000Hz
- Sensitivity : 2.5mV/Pa
- Impedance : 600Ω

Supplied with quick detachable holder with 3-pin professional XLR connector & 6m twin core shielded low noise cable.



Unidirectional Dynamic Multi Purpose Applications



AUD-99XLR®

For general PA applications, a robust and reliable microphone. Ideal for addressing an audience.

- Frequency Response : 50-15,000Hz
- Sensitivity : 2.5mV/Pa
- Impedance : 600Ω

Supplied with quick detachable holder with 3-pin professional XLR connector & 6m twin core shielded low noise cable.

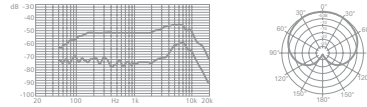

Unidirectional Dynamic PA Applications



AUD-98XLR®

High output Neodymium cartridge. Excellent intelligibility & wide frequency response. Attractive appearance.

- Frequency Response : 50-15,000Hz
- Sensitivity : 2.5mV/Pa
- Impedance : 600Ω

Supplied with quick detachable holder with 3-pin professional XLR connector & 6m twin core shielded low noise cable.

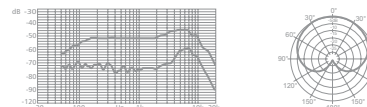

Unidirectional Dynamic PA Applications



AUD-97XLR

Attractive appearance. Neodymium cartridge. High intelligibility & wide frequency response.

- Frequency Response : 50-15,000Hz
- Sensitivity : 2.5mV/Pa
- Impedance : 600Ω

Supplied with quick detachable holder with 3-pin professional XLR connector & 6m twin core shielded low noise cable.

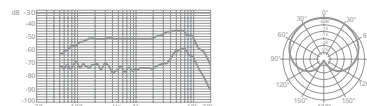

PROFESSIONAL ECONOMY SERIES

Unidirectional Dynamic Music & Vocal



ADM-511

Intelligible, crisp and bright sound suitable for all type of PA applications.

- Frequency Response : 50-15,000Hz
- Sensitivity : 2.0mV/Pa
- Impedance : 600Ω

Supplied with quick detachable holder with 3-pin professional XLR connector & 6m twin core shielded low noise cable.



Supercardioid Dynamic Music & Vocal



ADM-411

Neodymium cartridge. High intelligibility. Supercardioid polar pattern provides maximum isolation from nearby vocalists.

- Frequency Response : 50-15,000Hz
- Sensitivity : 2.5mV/Pa
- Impedance : 600Ω

Supplied with quick detachable holder with 3-pin professional XLR connector & 6m twin core shielded low noise cable.



Unidirectional Dynamic Multi Purpose Applications



ADM-311

High output Neodymium cartridge, excellent intelligibility & wide frequency response for clean sound reproduction.

- Frequency Response : 50-15,000Hz
- Sensitivity : 2.5mV/Pa
- Impedance : 600Ω

Supplied with quick detachable holder with 3-pin professional XLR connector & 6m twin core shielded low noise cable.

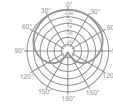
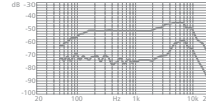

GENERAL PA ECONOMY SERIES WITH BUILT-IN MIC HOLDER

Unidirectional Dynamic All Purpose PA



AUD-99MS

For general PA applications, a robust and reliable microphone. Ideal for addressing an audience.

- Frequency Response : 50-15,000Hz
- Sensitivity : 2.5mV/Pa
- Impedance : 600Ω

Sturdy metal holder with 3-pin professional XLR connector & 6m twin core shielded low noise cable.

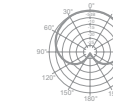
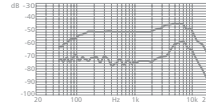

Unidirectional Dynamic All Purpose PA



AUD-77DX

Legendary multi-purpose microphone for general purpose PA applications like speech and music.

- Frequency Response : 50-15,000Hz
- Sensitivity : 2.5mV/Pa
- Impedance : 600Ω

Sturdy metal holder with 3-pin professional XLR connector & 6m shielded low noise cable.

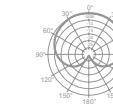
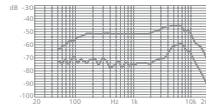

Unidirectional Dynamic All Purpose PA



AUD-70XLR

Robust and reliable microphone with non-reflective finish. Ideal for PA applications like speech/paging.

- Frequency Response : 50-15,000Hz
- Sensitivity : 2.5mV/Pa
- Impedance : 600Ω

Sturdy metal holder with 3-pin professional XLR connector & 5m shielded low noise cable.

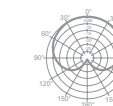
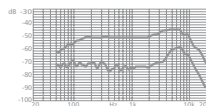

Unidirectional Dynamic All Purpose PA



AUD-65XLR

An economy model microphone for PA speech applications.

- Frequency Response : 100-10,000Hz
- Sensitivity : 2.0mV/Pa
- Impedance : 600Ω

Sturdy metal holder with 3-pin professional XLR connector & 5m shielded low noise cable.

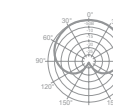
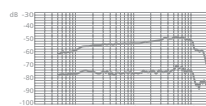

GENERAL PA ENTRY LEVEL ECONOMY SERIES

Unidirectional Dynamic



AUD-59XLR®

Attractive appearance, low cost PA microphone.

- Frequency Response : 100-10,000Hz
- Sensitivity : 2.5mV/Pa
- Impedance : 600Ω

Supplied with 4.5m shielded cable terminated with 3-pin XLR connector and quick detachable holder.

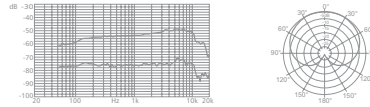

Unidirectional Dynamic



AUD-54

A basic economy microphone for Karaoke and PA applications.

- Frequency Response : 100-10,000Hz
- Sensitivity : 2.0mV/Pa
- Impedance : 600Ω

Supplied with 3m dedicated shielded cable with Ø6.3 mm (1/4") phone plug.

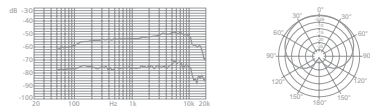

WIDE ANGLE LARGE DISTANCE PICK-UP

Unidirectional Stage & Studio



CSM-990

Excellent for interviews, musical instruments, stage, vocal and studio recording applications.

- Frequency Response : 20-18,000Hz
- Sensitivity (switchable) : 4.5mV/Pa, 2.2mV/Pa
- Impedance : 1000Ω
- Operates on : 1 × 1.5V (UM-3) Pencil Cell

Supplied with quick detachable holder, 10m twin core shielded low noise cable & 3-pin XLR connector.

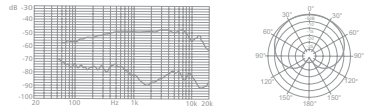

Unidirectional Stage & Studio



CUM-450

Professional unidirectional highly sensitive electret condenser microphone for stage, vocal & studio recording applications.

- Frequency Response : 20-18,000Hz
- Sensitivity : 7.5mV/Pa
- Impedance : 1000Ω
- Operates on : 1 × 1.5V (UM-3) Pencil Cell

Supplied with quick detachable holder, 6m twin core shielded low noise cable & 3-pin XLR connector.

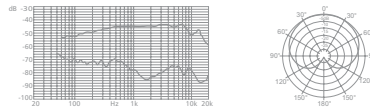

Supercardioid Dynamic Music & Vocal



TRINITY-411

Neodymium cartridge. High intelligibility. Supercardioid polar pattern provides maximum isolation from nearby vocalists.

- Frequency Response : 50-15,000Hz
- Sensitivity : 2.5mV/Pa
- Impedance : 600Ω

Supplied with three quick detachable holders in an attractive plastic carry case.

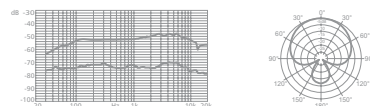

Pack of Three ADM-411



PA Microphones

TIE-CLIP SERIES

Omnidirectional Condenser



Unidirectional Condenser

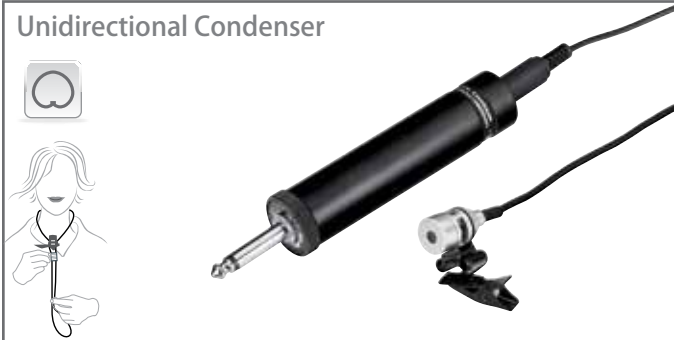

CTP-10DX

Miniature omnidirectional electret condenser lavalier type microphone with wide angle pick-up for lectures, interviews, religious places, recordings etc. A strong, fixed tie-clip prevents the microphone from being displaced accidentally. The cell container is provided to accommodate a single pencil cell. The cable length is 6m.

- Frequency Response : 100-15,000Hz
- Sensitivity : 5.0mV/Pa
- Impedance : 1000Ω
- Operates on : 1 × 1.5V (UM-3) Pencil Cell

UTP-30

Miniature unidirectional electret condenser lavalier type microphone for lectures, interviews, religious places, recordings etc. A strong, fixed tie-clip prevents the microphone from being displaced accidentally. Also a NECK-BAND is supplied if the tie-clip is not to be used. The cell container is provided to accommodate a single pencil cell. The cable length is 6m.

- Frequency Response : 100-15,000Hz
- Sensitivity : 7.0mV/Pa
- Impedance : 1000Ω
- Operates on : 1 × 1.5V (UM-3) Pencil Cell

Headband Microphones

Omnidirectional Condenser



Unidirectional Condenser



Unidirectional Condenser



EWM-100

Innovative, ear shaped, exceptionally sleek, ultra-light Headband Microphone for Stage Shows, Classrooms, Presentations, Discourses, Places of Worship etc.

- Omnidirectional electret condenser microphone.
- Adjustable microphone length for best position.
- External windscreen to reduce wind and pop noise.
- Terminated with Ø3.5mm mono phone plug for use with suitable bodypack transmitter of wireless microphone systems.

HBM-50

An elegant & reliable Headband Microphone. It can be worn around the head and the microphone positioned close to the lips. This allows the speaker to have his hands free and prevents background room noises from being freely picked up by the microphone.

- Ergonomic design for comfortable and convenient use.
- Allows hands-free use and reduces pickup of stray room noises.
- Suitable for various applications such as Announcements, Teaching, Presentations, Touring etc.

HBM-60CC

Condenser Headband Microphone supplied with 6m cable and a 1.5V cell container. Suitable for direct connection to an amplifier.

SPECIFICATIONS	EWM-100	HBM-50	HBM-60CC
FREQUENCY RESPONSE	20-20,000Hz	50-16,000Hz	50-16,000Hz
SENSITIVITY	5.6mV/Pa	5.6mV/Pa	5.6mV/Pa
NOMINAL IMPEDANCE	2000Ω	1000Ω	1000Ω
CABLE LENGTH	1.20m	1.25m	6m
OPERATING VOLTAGE	1.5V - 12V DC	1.5V - 9V DC	1.5V

AWM-700U2

Dual PA UHF Wireless Microphone



- Elegant & affordable high performance dual channel UHF wireless microphone available in different frequencies.
- Sturdy table-top dual channel receiver with frequency display.
- Separate volume control for both channels on the front panel of the receiver.
- Two handheld dynamic transmitters, each operating on 2 × 1.5V AA pencil cells.
- Separate balanced audio output from each channel through XLR connector and an unbalanced mixed output through 6.3mm (1/4") jack socket available from the receiver.
- Receiver operates on 12V DC through an AC adaptor supplied along with the transmitter.
- Ideal for: PA Applications... Stage & Auditoriums... Stadia... Seminar Halls... Places of Worship... Recreation Centres...

SPECIFICATIONS	TRANSMITTER
RF OUTPUT POWER	10mW (Max.)
FREQUENCY STABILITY	±0.005%
MODULATION MODE	FM
MICROPHONE ELEMENT	Dynamic, Cardioid
FREQUENCY RESPONSE	50-15,000Hz
POWER REQUIREMENT	3V (2 × 1.5V AA Pencil Cells)
CURRENT CONSUMPTION	≤ 150mA
CONTROLS	Microphone ON/OFF switch
INDICATION	Channel Frequency Display
DIMENSIONS	∅55 (L 250) mm
WEIGHT	220g (w/o battery)

SPECIFICATIONS	RECEIVER
AUDIO OUTPUT	Bal. 0dBu, Unbal. -10dBu
S/N RATIO	100dB
DISTORTION	≤1%
FREQUENCY RESPONSE	50-15,000Hz
POWER REQUIREMENT	220V-240V AC 50Hz for AC Adaptor (supplied alongwith)
CONTROLS	ON/OFF Switch, Volume Controls for Channel A & B
INDICATIONS	LEDs for RF & Audio Signal, Channel Frequency Display
DIMENSIONS	W210 × H42 × D147 mm
WEIGHT	405g

AWM-700UHL

PA UHF Wireless Microphone



- Elegant & affordable high performance dual channel UHF wireless microphone available in different frequencies.
- Sturdy table-top dual channel receiver with frequency display.
- Separate volume control for both channels on the front panel of the receiver.
- One handheld dynamic transmitter and one Bodypack transmitter, each operating on 2 × 1.5V AA pencil cells.
- Separate balanced audio output from each channel through XLR connector and an unbalanced mixed output through 6.3mm (1/4") jack socket available from the receiver.
- Receiver operates on 12V DC through an AC adaptor supplied along with the transmitter.
- Ideal for: PA Applications... Stage & Auditoriums... Stadia... Seminar Halls... Places of Worship... Recreation Centres...

SPECIFICATIONS	HANDHELD TX.	TIE-CLIP TX.
RF OUTPUT POWER	10mW (Max.)	15mW (Max.)
MODULATION MODE	FM	FM
MICROPHONE ELEMENT	Dynamic, Cardioid	Condenser, Omnidirectional
FREQUENCY RESPONSE	50-15,000Hz	80-15,000Hz
POWER REQUIREMENT	3V (2 × 1.5V AA Pencil Cells)	3V (2 × 1.5V AA Pencil Cells)
CURRENT CONSUMPTION	≤ 150mA	≤ 130mA
CONTROLS	Mic ON/OFF Switch	ON/OFF Switch, Vol. Control
INDICATION	Channel Frequency Display	Red LED for Transmitter ON, Frequency Display
DIMENSIONS	∅55 (L 250) mm	W67 × H32 × D95 mm
WEIGHT	220g (w/o battery)	60g (w/o battery)

SPECIFICATIONS	RECEIVER
AUDIO OUTPUT	Bal. 0dBu, Unbal. -10dBu
S/N RATIO	90dB
DISTORTION	≤1%
FREQUENCY RESPONSE	50-15,000Hz
POWER REQUIREMENT	220V-240V AC 50Hz from AC Adaptor (supplied alongwith)
CONTROLS	ON/OFF Switch, Volume Control for Channel A & B
INDICATIONS	LEDs for RF & Audio Signal, Channel Frequency Display
DIMENSIONS	W210 × H42 × D147 mm
WEIGHT	405g



PA Wireless Microphones

AWM-700UH

PA UHF Wireless Microphone



SPECIFICATIONS	TRANSMITTER
RF OUTPUT POWER	10mW (Max.)
FREQUENCY STABILITY	±0.005%
MODULATION MODE	FM
MICROPHONE ELEMENT	Dynamic, Cardioid
FREQUENCY RESPONSE	50-15,000Hz
POWER REQUIREMENT	3V (2 × 1.5V AA Pencil Cells)
CURRENT CONSUMPTION	≤ 150mA
CONTROLS	Microphone ON/OFF switch
INDICATION	Channel Frequency Display
DIMENSIONS	Ø55 (L 250) mm
WEIGHT	220g (w/o battery)

- Elegant & affordable high performance single channel UHF wireless microphone available in different frequencies.
- Sturdy table-top receiver with frequency display.
- Volume control knob on the front panel of the receiver.
- One handheld dynamic transmitter, operating on 2 × 1.5V AA pencil cells.
- Separate balanced output through XLR connector and an unbalanced output through 6.3mm (1/4") jack socket is available from the receiver.
- Receiver operates on 12V DC through an AC adaptor supplied along with the transmitter.
- Ideal for: PA Applications... Stage & Auditoriums... Stadia... Seminar Halls... Places of Worship... Recreation Centres...

SPECIFICATIONS	RECEIVER
AUDIO OUTPUT	Bal. 0dBu, Unbal. -10dBu
S/N RATIO	100dB
DISTORTION	≤1%
FREQUENCY RESPONSE	50-15,000Hz
POWER REQUIREMENT	220V-240V AC 50Hz from AC Adaptor (supplied alongwith)
CONTROLS	ON/OFF Switch, Volume Control
INDICATIONS	LEDs for RF & Audio Signal, Channel Frequency Display
DIMENSIONS	W210 × H42 × D147 mm
WEIGHT	372g

AWM-700UL

PA UHF Wireless Microphone



SPECIFICATIONS	TRANSMITTER
RF OUTPUT POWER	15mW (Max.)
MODULATION MODE	FM
MICROPHONE ELEMENT	Condenser, Omnidirectional
DYNAMIC RANGE	80dB
FREQUENCY RESPONSE	80-15,000Hz
CURRENT CONSUMPTION	≤ 130mA
POWER REQUIREMENT	3V (2 × 1.5V AA Pencil Cells)
CONTROLS	ON/OFF Switch, Volume Control,
INDICATIONS	Red LED for indicating transmitter ON, Frequency Display
DIMENSIONS	W67 x H32 x D95 mm
WEIGHT	60g (w/o battery)

- Attractive and versatile high performance single channel UHF wireless microphone available in different frequencies.
- Receiver has built-in 6.3mm (1/4") jack for unbalanced audio output and XLR connector for balanced audio output.
- Volume control knob & Frequency display on the front panel of the receiver.
- One bodypack transmitter, operating on 2x1.5V AA pencil cells.
- Bodypack transmitter has a two position slide switch for ON/OFF and one volume control.
- Receiver operates on 12V DC through an AC adaptor supplied alongwith the transmitter.
- Ideal for: PA Applications... Stage & Auditoriums... Stadia... Seminar Halls... Places of Worship... Recreation Centres...

SPECIFICATIONS	RECEIVER
AUDIO OUTPUT	Bal. 0dBu, Unbal. -10dBu
S/N RATIO	90dB
DISTORTION	≤1%
FREQUENCY RESPONSE	50-15,000Hz
DYNAMIC RANGE	>90dB
POWER REQUIREMENT	240V AC 50Hz from AC Adaptor (supplied along with)
CONTROLS	ON/OFF Switch, Volume Control
INDICATIONS	LEDs for RF & Audio Signal, Channel Frequency Display
DIMENSIONS	W210 × H42 × D147 mm
WEIGHT	372g

ABW-400®UH PA UHF Wireless Microphone



- Attractive and versatile high performance single channel UHF wireless microphone available in different frequencies.
- Bodypack receiver has built-in 6.3mm (1/4") jack plug which provides unbalanced audio output.
- Volume control knob with RF & POWER LED on the front side of the receiver.
- One handheld dynamic transmitter, operating on 2x1.5V AA pencil cells.
- Receiver has a three position slide switch for ON/STANDBY/OFF position and operates on 2x1.5V AA pencil cells.
- Ideal for: PA Applications... Stage & Auditoriums... Stadia... Seminar Halls... Places of Worship... Recreation Centres...

SPECIFICATIONS	TRANSMITTER
RF OUTPUT POWER	10mW (Max.)
FREQUENCY STABILITY	±0.005%
MODULATION MODE	FM
MICROPHONE ELEMENT	Dynamic, Cardioid
FREQUENCY RESPONSE	50-15,000Hz
POWER REQUIREMENT	3V (2 × 1.5V AA Pencil Cells)
CURRENT CONSUMPTION	≤ 150mA
CONTROLS	Microphone ON/OFF switch
INDICATION	LED for microphone ON
DIMENSIONS	Ø55 (L 250) mm
WEIGHT	220g (w/o battery)

SPECIFICATIONS	RECEIVER
AUDIO OUTPUT	Unbal. -10dBu
S/N RATIO	100dB
DISTORTION	≤ 1%
FREQUENCY RESPONSE	50-15,000Hz
POWER REQUIREMENT	3V (2 × 1.5V AA Pencil Cells)
CURRENT CONSUMPTION	≤ 150mA
CONTROLS	ON/OFF/SB Switch, Volume Control
INDICATIONS	LEDs for Power & RF Signal
DIMENSIONS	W62 × H128 × D26 mm
WEIGHT	65g (w/o battery)

ABW-400®UL PA UHF Wireless Microphone



- Attractive and versatile high performance single channel UHF wireless microphone available in different frequencies.
- Bodypack receiver has built-in 6.3mm (1/4") phone plug which provides unbalanced audio output.
- Volume control knob with RF & POWER LED on the front side of the receiver.
- One Bodypack transmitter, operating on 2x1.5V AA pencil cells.
- Supplied with Tie-Clip as well as Neck-Band condenser microphone.
- Receiver has a three position slide switch for ON/STANDBY/OFF position and operates on 2x1.5V AA pencil cells.
- Ideal for: PA Applications... Stage & Auditoriums... Stadia... Seminar Halls... Places of Worship... Recreation Centres...

SPECIFICATIONS	TRANSMITTER
RF OUTPUT POWER	15mW (Max.)
FREQUENCY STABILITY	±0.005%
MODULATION MODE	FM
MICROPHONE ELEMENT	Condenser, Ominidirectional
FREQUENCY RESPONSE	80-15,000Hz
POWER REQUIREMENT	3V (2 × 1.5V AA Pencil Cells)
CURRENT CONSUMPTION	≤ 130mA
CONTROLS	Microphone ON/OFF switch, Volume Control
INDICATION	Red LED for microphone ON
DIMENSIONS	W67 × H32 × D95 mm
WEIGHT	60g (w/o battery)

SPECIFICATIONS	RECEIVER
AUDIO OUTPUT	Unbal. -10dBu
S/N RATIO	100dB
DISTORTION	≤ 1%
FREQUENCY RESPONSE	50-15,000Hz
POWER REQUIREMENT	3V (2 × 1.5V AA Pencil Cells)
CURRENT CONSUMPTION	≤ 150mA
CONTROLS	Power ON/OFF/SB Switch, Volume Control
INDICATIONS	LEDs for Power & RF Signal
DIMENSIONS	W62 × H128 × D26 mm
WEIGHT	65g (w/o battery)



PA Wireless Microphones

AWM-520V2

DUAL PA VHF Wireless Microphones



SPECIFICATIONS	TRANSMITTER
RF OUTPUT POWER	10mW (Max.)
MODULATION MODE	FM
MICROPHONE ELEMENT	Dynamic, Cardioid
FREQUENCY RESPONSE	40-15,000Hz
POWER REQUIREMENT	9V Battery
CURRENT CONSUMPTION	<30mA
CONTROLS	On/Mute/Off Switch
INDICATION	RED LED (Momentary glow for RF ON & Permanent glow for Low Battery)
DIMENSIONS	∅ 48 (L 240) mm
WEIGHT	250g (w/o battery)

- Elegant and affordable dual channel VHF high band wireless microphones available in different frequencies.
- Handheld dynamic unidirectional transmitter with a three position slide switch and Low Battery LED indicator.
- Stylish table-top receiver with noise squelch circuitry.
- ALC circuit handles high sound pressure levels without distortion.
- Separate output volume controls for both channels on the front panel of the receiver.
- Power ON/OFF switch and 6.3mm (1/4") phone jack for audio output on the rear panel of the receiver.
- Each transmitter operates on 1 × 9V battery.
- Receiver operates on 12V DC through an AC adaptor, supplied along with the transmitter.
- Ideal for: PA Applications... Stage & Auditoriums... Stadia... Seminar Halls... Places of Worship... Recreation Centres...

SPECIFICATIONS	RECEIVER
FREQUENCY STABILITY	± 0.005%
AUDIO OUTPUT	0-50mV
S/N RATIO	>90dB
DISTORTION	<0.5%
ANTENNA TYPE	Telescopic
POWER REQUIREMENT	220V-240V AC 50Hz for AC adaptor (supplied alongwith)
CONTROLS	Power Switch, Output Volume Control
INDICATION	Red LED for Power ON & Signal
DIMENSIONS	W200 × H55 × D155 mm
WEIGHT	350g

AWM-520VHL

DUAL PA VHF Wireless Microphones



SPECIFICATIONS	HANDHELD TX.	TIE-CLIP TX.
RF OUTPUT POWER	10mW (Max.)	10mW (Max.)
MODULATION MODE	FM	FM
MICROPHONE ELEMENT	Dynamic, Cardioid	Condenser, Cardioid
FREQUENCY RESPONSE	40-15,000Hz	40-12,000Hz
CURRENT CONSUMPTION	<30mA	<30mA
CONTROLS	ON/MUTE/ OFF Switch	ON/MUTE/ OFF Switch, Volume Control
INDICATION	Red LED for Mic ON	Green LED indicating power of cells
DIMENSIONS	∅48 × L240 mm	W63 × H33 × D100 mm
WEIGHT	250g (w/o battery)	90g (w/o battery)

- Elegant and affordable dual channel VHF high band wireless microphones available in different frequencies.
- Consists of a handheld dynamic unidirectional transmitter and a bodypack transmitter.
- Stylish table-top receiver with noise squelch circuitry.
- ALC circuit handles high sound pressure levels without distortion.
- Separate output volume controls for both channels on the front panel of the receiver.
- Power ON/OFF switch and 6.3mm (1/4") phone jack for audio output on the rear panel of the receiver.
- Each transmitter operates on 1 × 9V battery.
- Receiver operates on 12V DC through an AC adaptor, supplied along with the transmitter.
- Ideal for: PA Applications... Stage & Auditoriums... Stadia... Seminar Halls... Places of Worship... Recreation Centres...

SPECIFICATIONS	RECEIVER
FREQUENCY STABILITY	± 0.005%
AUDIO OUTPUT	0-50mV adjustable
S/N RATIO	>90dB
DISTORTION	<0.5%
ANTENNA TYPE	Telescopic
POWER REQUIREMENT	220V-240V AC 50Hz for AC adaptor (supplied alongwith)
CONTROLS	Power Switch, Output Volume Control
INDICATION	Red LED FOR POWER ON, Green LEDs for RF indication
DIMENSIONS	W200 × H55 × D155 mm
WEIGHT	350g

AWM-520VL

PA VHF Wireless Microphone



- Elegant and affordable single channel VHF wireless microphone available in different frequencies.
- 6.3mm (1/4") phone jack for audio output on the rear panel of the receiver. Receiver operates on 9V DC through an AC adaptor, supplied along with the transmitter.

SPECIFICATIONS	TIE-CLIP TX.	HANDHELD TX.
RF OUTPUT POWER	10mW (Max.)	10mW (Max.)
MODULATION MODE	FM	FM
MICROPHONE ELEMENT	Condenser, Cardioid	Dynamic, Cardioid
FREQUENCY RESPONSE	40-15,000Hz	40-15,000Hz
POWER REQUIREMENT	9V Battery	9V Battery
CURRENT CONSUMPTION	<30mA	<30mA
CONTROLS	ON/OFF Switch, Output Volume Control	ON/MUTE/OFF Switch
INDICATION	Red LED for Mic ON	Momentary RED: RF ON Permanent RED: Low Batt.
DIMENSIONS	W63 × H33 × D100 mm	∅48 (L 240) mm
WEIGHT	90g (w/o battery)	250g (w/o battery)

AWM-520VH

PA VHF Wireless Microphone



- AWM-520VL: Bodypack Transmitter with ON/OFF switch and a LED for ON indication.
- AWM-520VH: Handheld Transmitter with three position slide switch and a Low Battery LED indication.
- Ideal for: PA Applications... Stage & Auditoriums... Stadia... Seminar Halls... Places of Worship... Recreation Centres...

SPECIFICATIONS	RECEIVER
FREQUENCY STABILITY	± 0.005%
AUDIO OUTPUT	0-50mV
S/N RATIO	>90dB
DISTORTION	<0.5%
ANTENNA TYPE	Telescopic
POWER REQUIREMENT	220V-240V AC 50Hz for AC adaptor (supplied alongwith)
CONTROLS	Power Switch, Output Volume Control
INDICATION	Power ON LED, Signal LEDs
DIMENSIONS	W152×H40×D110 mm
WEIGHT	200g

AWM-495®V2

DUAL PA VHF Wireless Microphones



- Compact, lightweight, Dual Channel VHF Wireless Microphone System.
- Operates at Quartz Crystal Locked VHF High Band frequency and available in different frequency groups. Two transmitters with separate frequencies and one dual channel receiver.
- Internal antenna in the transmitter and two telescopic antennas in the receiver for clear and distortion free reception.
- Receiver operates on 12V DC through an AC Adaptor supplied alongwith the system. Each transmitter operates with a 2x1.5V AA Pencil Cell.
- Transmitters have 2-position ON/OFF slide switch.
- Audio output from receiver available at OUT 1 & OUT 2 individually and as mixed output at OUT 1 + 2.
- Ideal for: PA Applications... Stage & Auditoriums... Seminar Halls... Places of Worship... Recreation Centres...

SPECIFICATIONS	TRANSMITTER
RF OUTPUT POWER	<15mW (Max.)
MODULATION MODE	FM (F3E)
MICROPHONE ELEMENT	Dynamic, Cardioid
FREQUENCY RESPONSE	50-15,000Hz
DYNAMIC RANGE	80dB
CURRENT CONSUMPTION	≤100mA
POWER REQUIREMENT	3V (2 × 1.5V AA Pencil Cells)
ANTENNA TYPE	Internal dipole
CONTROLS	Transmitter ON/OFF switch
INDICATIONS	Red & Green LEDs for indicating transmitter ON
DIMENSIONS	∅55 (L248) mm
WEIGHT	180g (w/o battery)

SPECIFICATIONS	RECEIVER
FREQUENCY STABILITY	± 0.005% Quartz Crystal Controlled
RECEIVING METHOD	Non-diversity
AUDIO OUTPUT	Channel 1: 0-55mV/1kΩ, Channel 2: 0-55mV/1kΩ, Channel 1+2: 0-55mV/1kΩ
SIGNAL TO NOISE RATIO	> 80dB
DISTORTION	< 0.5%
FREQUENCY RESPONSE	50-15,000Hz
ANTENNA	Telescopic
POWER REQUIREMENT	240V AC 50Hz for AC adaptor (supplied along with)
CONTROLS	Power ON / OFF Switch, Volume Control for Channel-1, Volume Control for Channel-2
DIMENSIONS	W230 × H42 × D150 mm
WEIGHT	353 g



PA Wireless Microphones

AWM-495[®]V1 PA VHF Wireless Microphone



SPECIFICATIONS	TRANSMITTER
RF OUTPUT POWER	<15mW (Max.)
MODULATION MODE	FM (F3E)
MICROPHONE ELEMENT	Dynamic, Cardioid
DYNAMIC RANGE	80dB
FREQUENCY RESPONSE	50-15,000Hz
ANTENNA TYPE	Internal dipole
CURRENT CONSUMPTION	≤100mA
POWER REQUIREMENT	3V (2 × 1.5V AA Pencil Cells)
CONTROLS	Transmitter ON/OFF Switch
INDICATION	Green LED for indicating microphone is ON
DIMENSIONS	∅55 (L248) mm
WEIGHT	180g (w/o battery)

- Compact, lightweight, Single Channel VHF Wireless Microphone System.
- Operates at Quartz Crystal Locked VHF High Band frequency and available in different frequencies.
- Internal antenna in the Transmitter and a telescopic antenna in the Receiver for clear and distortion free reception.
- Receiver operates on 12V DC through an AC Adaptor supplied alongwith the system. The transmitter operates with a 2x1.5V AA Pencil cell.
- Transmitters have 2-position ON/OFF slide switch.
- Audio output from receiver available through 6.3mm (1/4") jack socket.
- Ideal for: PA Applications... Stage & Auditoriums... Seminar Halls... Places of Worship... Recreation Centres...

SPECIFICATIONS	RECEIVER
FREQUENCY STABILITY	± 0.005% Quartz Crystal Controlled
RECEIVING METHOD	Non-diversity
AUDIO OUTPUT	0-55mV/1kΩ
SIGNAL TO NOISE RATIO	> 80dB
DISTORTION	< 0.5%
FREQUENCY RESPONSE	50-15,000Hz
ANTENNA	Telescopic
POWER REQUIREMENT	240V AC 50Hz for AC adaptor (supplied along with)
CONTROLS	Power ON/OFF Switch, Output Volume Control
INDICATIONS	Red LED for Power ON, Green LED for RF reception
DIMENSIONS	W230 x H42 x D150 mm
WEIGHT	305g

AWM-495[®]VHL DUAL PA VHF Wireless Microphones



SPECIFICATIONS	HANDHELD TX.	BODYPACK TX.
RF OUTPUT POWER	15mW (Max.)	15mW (Max.)
MODULATION MODE	FM (F3E)	FM (F3E)
MICROPHONE ELEMENT	Dynamic, Cardioid	Condenser, Omnidirectional
DYNAMIC RANGE	80dB	80dB
FREQUENCY RESPONSE	50-12,000Hz	80-15,000Hz
CURRENT CONSUMPTION	≤130mA	≤130mA
POWER REQUIREMENT	3V (2 × 1.5V AA Pencil Cells)	3V (2 × 1.5V AA Pencil Cells)
CONTROLS	Transmitter ON/OFF Switch	Switch, Volume Control
INDICATION	Red LED for indicating transmitter ON	Red LED for indicating transmitter ON
DIMENSIONS	∅55 (L248) mm	W67 x H32 x D95 mm
WEIGHT	180g (w/o battery)	60g (w/o battery)

- Compact, lightweight, Dual Channel VHF Wireless Microphone System available in different frequency groups.
- Combination of a handheld dynamic transmitter & a bodypack transmitter for a wide variety of applications.
- Internal antennas in the transmitter and two telescopic antennas in the Receiver for clear and distortion free reception.
- Receiver operates on 12V DC through an AC Adaptor supplied alongwith the system. Each transmitter operates with a 2x1.5V AA Pencil Cells.
- Transmitters have 2-position ON/OFF slide switch.
- Audio output from receiver available at OUT 1 & OUT 2 individually and as mixed output at OUT 1 + 2.
- Ideal for: PA Applications... Stage & Auditoriums... Seminar Halls... Places of Worship... Recreation Centres...

SPECIFICATIONS	RECEIVER
FREQUENCY STABILITY	± 0.005% Quartz Crystal Controlled
RECEIVING METHOD	Non-diversity
AUDIO OUTPUT	Channel 1: 0-55mV / 1kΩ, Channel 2: 0-55mV / 1kΩ Channel 1+2: 0-55mV / 1kΩ
SIGNAL TO NOISE RATIO	> 80dB
DISTORTION	< 0.5%
FREQUENCY RESPONSE	50-15,000Hz
ANTENNA	Telescopic
POWER REQUIREMENT	240V AC 50Hz for AC adaptor (supplied along with)
CONTROLS	Power On / Off Switch, Volume Control for Channel-1, Volume Control for Channel-2
INDICATIONS	Red LED for Power ON, Green LED for RF reception on Channel-1, Green LED for RF reception on Channel-2
DIMENSIONS	W230 x H42 x D150 mm
WEIGHT	353g

CWM-400V

PA VHF Wireless Microphone



SPECIFICATIONS	TRANSMITTER
RF OUTPUT POWER	10mW (Max.)
MODULATION MODE	FM
MICROPHONE ELEMENT	Condenser, Cardioid
FREQUENCY RESPONSE	80-15,000Hz
POWER REQUIREMENT	2× 1.5V AAA Alkaline Cells
CURRENT CONSUMPTION	<60mA
CONTROLS	ON/OFF Push Switch
INDICATION	Red ring LED in the gooseneck & Red round LED in the base
DIMENSIONS	W90×H60×D130 mm (mic base)
WEIGHT	550g (without battery)

- Compact and elegant high band VHF Wireless Microphone system with four gooseneck microphones.
- Available in different frequencies (2 sets of 4 each).
- Transmitter are unidirectional condenser type, fitted with gooseneck, ON/OFF switch and an indicator LED.
- Sleek table-top receiver which can receive signals from upto 4 gooseneck transmitters.
- Individual output volume control and a RF LED for each channel is provided on the front panel of the receiver.
- Separate 6.3mm (¼") phone jack for audio output from each channel is available on the rear panel.
- Receiver operates on 12V DC through an AC adaptor, supplied along with. Transmitter operates with 2× 1.5V AAA alkaline cells.

SPECIFICATIONS	RECEIVER
FREQUENCY STABILITY	± 0.005%
AUDIO OUTPUT	0-50mV adjustable (each channel)
S/N RATIO	>80dB
DISTORTION	<0.5%
ANTENNA TYPE	Telescopic
POWER REQUIREMENT	220V-240V AC 50Hz for AC adaptor (supplied alongwith)
CONTROLS	Power Switch, Output Volume Control for each channel
INDICATION	Power ON LED, Signal LEDs
DIMENSIONS	W420×H54×D210 mm
WEIGHT	1.80kg

AWM-630VG

PA VHF Wireless Desktop Microphone



SPECIFICATIONS	TRANSMITTER
RF OUTPUT POWER	10mW (Max.)
MODULATION MODE	FM
MICROPHONE ELEMENT	Condenser, Cardioid
FREQUENCY RESPONSE	100-12,000Hz
POWER REQUIREMENT	2× 1.5V Pencil Cells
CURRENT CONSUMPTION	<40mA
CONTROLS	ON/OFF Switch
INDICATION	Red Ring LED in the gooseneck
DIMENSIONS	W145×H50×D155 mm
WEIGHT	560g (without battery)

- Stylish & rugged high band VHF wireless desktop microphone & receiver available in different frequencies.
- Condenser unidirectional transmitter has a sleek gooseneck with ring LED indicator.
- Transmitter has a push-type ON/OFF switch.
- Highly sensitive table-top receiver with a telescopic antenna & noise squelch circuitry.
- Transmitter also has a male XLR connector & connecting cable so that wired mode can also be used, if required.
- Transmitter operates with 2× 1.5V UM-3 pencil cells.
- Receiver operates on 9V DC through an AC adaptor, supplied along with.

SPECIFICATIONS	RECEIVER
FREQUENCY STABILITY	± 0.005%
AUDIO OUTPUT	0-50mV adjustable
S/N RATIO	>90dB
DISTORTION	<0.5%
ANTENNA TYPE	Telescopic
POWER REQUIREMENT	220V-240V AC 50Hz for AC adaptor (supplied alongwith)
CONTROLS	Power Switch, Output Volume Control
INDICATION	Red LED for Power ON, Green & Red LEDs for Signal
DIMENSIONS	W152×H40×D110 mm
WEIGHT	200g



PA Gooseneck Microphones

GENERAL PA INSTALLED SOUND SERIES

These professional high quality PA Gooseneck Microphones are suitable for various PA applications such as on Lecterns and Podiums, Open Conferences etc. The sleek and slender design makes the microphones unobtrusive. Model GM-601LM has a ring LED indication, useful in open conferences; while GM-615 and GM-611M have a longer reach. GM-605 is shorter and of the same length as GM-601LM. AGN-500 and AGN-480 are fitted with stand mount base and are supplied with 6m twin core shielded low noise cable.

- Wide frequency response.
- High front-to-back rejection for more gain before feedback.
- Built-in XLR socket.



GM-615

GM-611M

GM-605

GM-601LM

AGN-500

AGN-480

Unidirectional Electret Condenser Microphones

Unidirectional Dynamic Microphones

SPECIFICATIONS	GM-615	GM-611M	GM-605	GM-601LM	AGN-500	AGN-480
FREQUENCY RESPONSE	20-18,000Hz	100-15,000Hz	50-16,000Hz	100-15,000Hz	50-15,000Hz	50-10,000Hz
IMPEDANCE	1000Ω	1000Ω	1000Ω	1000Ω	500Ω	600Ω
SENSITIVITY	7.5mV/Pa	7.0mV/Pa	4.0mV/Pa	7.0mV/Pa	2.2mV/Pa	2.0mV/Pa
POWER SOURCE	1.5V-9V DC	1.5V-9V DC	1.5V-9V DC	3V-9V DC	—	—
OVERALL LENGTH	585 mm (23")	585 mm (23")	460 mm (18")	460 mm (18")	395 mm (15½")	470 mm (18½")

G-622S

Strong 254 mm (10") long flexible gooseneck shaft in silver finish Exclusively designed for converting any XLR microphone into a gooseneck microphone. A female XLR connector is provided at the top for connecting any XLR microphone and a male XLR connector has been provided at the bottom for connecting the microphone cable. Fitted with stand mount base to match all Ahuja PA Microphone Stands.

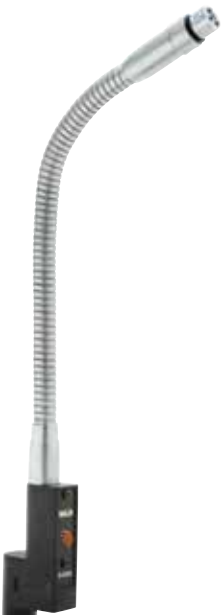

G-611S

This is a mic stand adaptor for Ahuja gooseneck microphones model GM-615, GM-611M and GM-605. It has a well styled rugged heavy duty aluminium die-cast body with a female XLR connector for directly mounting the gooseneck microphone. A male XLR connector has been provided at the bottom for connecting the cable.

- 10m twin core shielded low noise cable with in-line cell housing.
- Operates on 1.5V (1×UM-3) pencil cell provided.
- Special circuitry employed for minimal switch noise.
- Threaded brass ferrule with 5/8"×27 TPI, suitable for standard microphone stands.



GMB-6C

This is a sturdy, heavy duty base made of die-cast aluminium suitable for Ahuja electret condenser gooseneck microphones. It has a female XLR connector for directly mounting the gooseneck microphone and a male XLR socket at the rear for connecting standard microphone cable to the amplifier.

- Heavy weight housing with anti-skid feet ensures stability.
- 10m twin core shielded low noise mic cable with XLR connector & 6.3mm (¼") phone plug.
- Built-in cell housing for 2×UM-3 pencil cells (3V) for operating the condenser microphone.
- On/Off switch provided. Special electronic circuitry for minimal switch noise.





PGM-481 PA Gooseneck Microphone

A sleek and 23" (585mm) long gooseneck condenser microphone with natural and clear sound. Ideal for high end applications like auditoria, conference halls and podiums for VIPs.

- Suitable for use with PGB-48 base and powered by 48V phantom supply model APS-482 or equivalent.

Frequency Response	50-16,000Hz
Sensitivity	5.5mV/Pa
Impedance	200Ω
Power Req'd.	9V-52V DC
Overall Length	585mm (23")

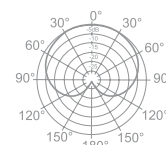
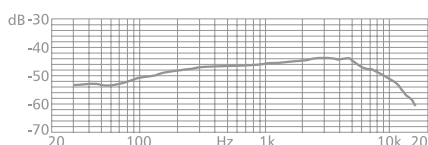

PGB-48 Gooseneck Microphone Base

- An elegantly designed, sturdy & heavy duty metal base for use with a phantom gooseneck microphone PGM-481 and a suitable 48V phantom supply source APS-482.
- Provided with an ON/OFF switch and LED indication.
- Balanced output allowing longer cable length.



ABM-301M ABM-301H

ABM-301M/ABM-301H PA Boundary Layer Microphones

Elegantly designed boundary layer microphones for table-top or stage use. Provided with push on/off mute switch, LED indicator, rubber base for reducing shock noise, and a switchable bass filter to eliminate unwanted low frequency noise. Extra smooth wide frequency response and clear, highly intelligible sound. Use with 48V phantom supply.

- ABM-301M is omnidirectional, and recommended for conference tables, video conferencing etc.
- ABM-301H is hypercardioid, and recommended for use on stage.
- Suitable for use with 48V phantom supply model APS-482 or equivalent.

Frequency Response	:	40-16,000Hz
Sensitivity	:	15mV/Pa
Impedance	:	100Ω
Bass Filter	:	-10dB at 80Hz
Cable Length	:	5.8m
Power Requirement	:	9V-52V DC

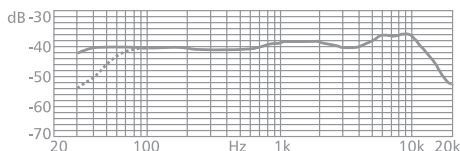

PA Phantom Microphones

Front View



Rear View



APS-482

48V Phantom Supply

- High quality, high reliability power supply for use with condenser microphones using 48V DC phantom supply.
- Fitted with ON/OFF switch, power LED and XLR microphone input and output sockets.
- Provided with XLR input & output sockets for connecting upto TWO phantom microphones.
- Suitable for use with microphones PGM-481, ABM-301M & ABM-301H.
- BIS approved.

SPECIFICATIONS

Operating Voltage	240V AC 50Hz
Phantom Supply	48V DC
Mic Inputs	2 x Female XLR
Mic Outputs	2 x Male XLR (For Amplifier)
Compliance	IS616:2017 (BIS Certified)
Dimensions	W145 x H60 x D130 mm
Weight	1.10kg

Paging Microphones



ACM-96



ACM-96CH

ACM-96

ACM-96CH with MULTI Tone Chime

Single zone desktop paging microphone with a sturdy, aluminium die-cast top and special high reliability switches with integrated LED indicators.

Fitted with a flexible 300mm (12") gooseneck and a high quality unidirectional dynamic cartridge. Supplied with 6 mtrs. twin core shielded low noise cable with 6.3mm (1/4") phone plug.

ACM-96CH is also provided with a multi tone electronic chime, and operates on 2 x 1.5V (UM-3) pencil cells. Desired chime sound level can be set through preset at the bottom side of ACM-96CH.

SPECIFICATIONS

FREQUENCY RESPONSE	50-10,000Hz
SENSITIVITY	2.0mV/Pa
IMPEDANCE	600Ω

Special Purpose Microphone

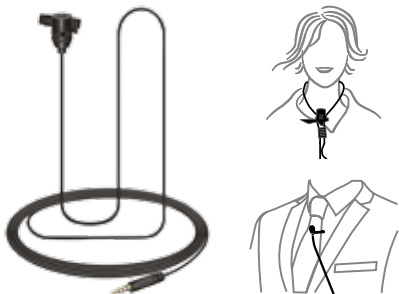

MTP-20

Lavalier Microphone



- Tie-Clip electret condenser microphone with unidirectional characteristics. Ideal for Smartphones, PC/Laptop, Camcorders DSLR, Audio Recorder etc.

Frequency Response	100-15,000Hz
Sensitivity	7.0mV/Pa
Output Connection	3.5mm (1/8") 4-Pole Plug (TRRS)
Cable Length	5mtrs.



MM-60M

PA Microphone for Mobile Use

- Professional dynamic microphone for mobile applications.
- Close-to-lip speaking to avoid background noise.
- Flexible coiled cord for easy extension of wire length.

Frequency Response	200-6,000Hz
Sensitivity	2.3mV/Pa
Impedance	500Ω



Hallmark of Reliability!



Speakers

Speakers have the unique and exacting responsibility to reproduce the electrical sound signal faithfully. Also, the reliability and ruggedness of speakers is a vital issue in sound system reliability.

AHUJA speakers are designed for excellent sound reproduction under all conceivable conditions.

High power speakers, sub-woofers, horn speakers, column speakers, wall speakers, ceiling speakers, garden speakers, sound projectors, PA drivers etc. AHUJA has speakers for all applications...

Applications

Airports | Conventions | DJs | Stadiums | Electioneering | Fairs & Exhibitions
Defence Installations | Bus Terminals | Announcements & Music | Mobile PA
Schools & Colleges | Places of Worship

PA Driver Units



AU-35
35W/16Ω



AU-40®
40W/16Ω



AU-60®
60W/16Ω



AU-40®XT
40W/100V



AU-50®XT
50W/100V

- Weatherproof and rugged construction.
- High SPL, crisp penetrating sound.
- Voice coils precision-wound on an aluminium bobbin for efficient heat dissipation.
- Models AU-40®XT and AU-50XT have a built-in 100V transformer with easily selectable power taps/impedance by changing the position of the rotary switch at the rear.
- Degree of protection IP 66 provided, when mounted on a reflex horn, against foreign particles such as dust and jets of water thus making them ideal for outdoor use. Meets EN 60529.

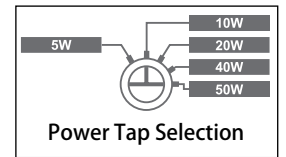
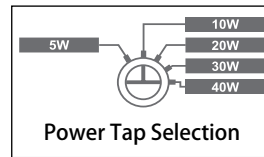

SPECIFICATIONS	AU-35	AU-40®	AU-60®	AU 40®XT	AU 50®XT
INPUT POWER	35W RMS/53W Max.	40W RMS/60W Max.	60W RMS/90W Max.	40W RMS/60W Max.	50W RMS/70W Max.
IMPEDANCE/POWER TAPS	16Ω	16Ω	16Ω	On 100V Line	On 100V Line
	—	—	—	250Ω/40W, 330Ω/30W	200Ω/50W, 250Ω/40W
	—	—	—	500Ω/20W, 1kΩ/10W	500Ω/20W, 1kΩ/10W
	—	—	—	2kΩ/5W	2kΩ/5W
FREQUENCY RESPONSE	160-7,000Hz	160-7,000Hz	160-7,000Hz	160-7,000Hz	160-7,000Hz
SPL at 1kHz	112dB/1W/1m 127dB/35W/1m	112.5dB/1W/1m 128.5dB/40W/1m	113.5dB/1W/1m 132dB/60W/1m	112.5dB/1W/1m 128.5dB/40W/1m	113dB/1W/1m 130dB/50W/1m
TEMPERATURE RANGE	-30° to +70° C	-30° to +70° C	-30° to +70° C	-30° to +70° C	-30° to +70° C
THROAT COUPLING	1-3/8" - 18TPI, Throat Couple No.1				
DIMENSIONS	ø113 x H89 mm	ø116 x H98 mm	ø126 x H100 mm	ø150 x H137 mm	ø150 x H143 mm
WEIGHT	1.48kg	1.72kg	2.05kg	2.24kg	2.47kg
MATERIAL	Die-cast Aluminium Acoustic Head (Flange)				

PA Horn Speakers

EHC-10 10W/8Ω / EHC-10XT 10W/100V

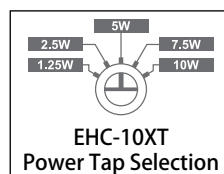

SPECIFICATIONS	EHC-10	EHC-10XT
INPUT POWER	10W RMS/15W Max.	10W RMS/15W Max.
IMPEDANCE / POWER TAPS	8Ω	10/7.5/5/2.5/1.25W
FREQUENCY RESPONSE	350-7,000Hz	350-7,000Hz
SPL at 1kHz	102dB/1W/1m, 112dB/10W/1m	102dB/1W/1m, 112dB/10W/1m
DIMENSIONS	180 × 130 (L195) mm	180 × 130 (L215) mm
WEIGHT	930g	1.17kg
MATERIAL	ABS (UV Protected)	ABS (UV Protected)

- Compact, sturdy and light weight weather proof horn speakers for a variety of mobile PA and installed PA applications.
- Available in low impedance 8Ω version as EHC-10 and high impedance 100V version as EHC-10XT.
- Features high acoustical efficiency together with intelligible and effective penetrating sound.
- Constructed with tough UV protected ABS plastic components.
- Provided with strong metal bracket for rigid mounting. Stand mounting bolts are in stainless steel.
- Fitted with 0.6m (2') 2-core sheathed speaker cable, secured through a water-tight, tug-proof cable gland.
- They meet European Union regulations and comply with low voltage directive standard EN 60065. Degree of protection IP 66 is provided against foreign particles such as dust and jets of water, thus making them ideal for outdoor use.

Low Impedance PA Horn Speakers



UHC-30
30W/8Ω

UHC-25
25W/8Ω

UHC-15
15W/8Ω



SUH-40
40W/16Ω

SUH-25
25W/8Ω

SUH-15
15W/8Ω

- Ahuja high quality, weather proof horn speakers are compact, light weight and rugged. They are moulded in tough UV protected ABS plastic for longer lasting finish.
- Designed for acoustical efficiency providing a high SPL for a clean intelligible sound and effective sound penetration.
- Voice coils are precision-wound on an aluminium bobbin for good heat dissipation from the coil, thereby improving efficiency and reliability.
- Fitted with 0.6m (2') 2-core sheathed speaker cable, secured through a water-tight, tug-proof cable gland.
- These models have been provided with robust metal brackets/stands rotating through 270°. Rectangular models are particularly suitable for mounting on vehicles & boats.
- They meet European Union regulations and comply with low voltage directive standard EN 60065. Degree of protection IP 66 is provided against foreign particles such as dust and jets of water, thus making them ideal for outdoor use.

UV Protected ABS Bell, Reflector and Back Cover. External Stand Mounting Bolts in Stainless Steel

SPECIFICATIONS	UHC-30	UHC-25	UHC-15	SUH-40	SUH-25	SUH-15
INPUT POWER	30W RMS/45W Max.	25W RMS/38W Max.	15W RMS/23W Max.	40W RMS/60W Max.	25W RMS/38W Max.	15W RMS/23W Max.
IMPEDANCE	8 Ω	8 Ω	8 Ω	16 Ω	8 Ω	8 Ω
FREQUENCY RESPONSE	240-10,000Hz	250-10,000Hz	275-7,000Hz	180-7,000Hz	250-10,000Hz	275-7,000Hz
SPL at 1kHz	108dB/1W/1m 123dB/30W/1m	108dB/1W/1m 122dB/25W/1m	106dB/1W/1m 118dB/15W/1m	112.5dB/1W/1m 128.5dB/40W/1m	108dB/1W/1m 122dB/25W/1m	106dB/1W/1m 118dB/15W/1m
DIMENSIONS	ø313 (L285) mm	ø274 (L280) mm	ø205 (L245) mm	400 x 200 (L385) mm	315 x 165 (L290) mm	253 x 152 (L265) mm
WEIGHT	1.98kg	1.94kg	1.44kg	3.20kg	1.90kg	1.51kg
MATERIAL	ABS (UV Protected)	ABS (UV Protected)	ABS (UV Protected)	ABS (UV Protected)	ABS (UV Protected)	ABS (UV Protected)



100V PA Horn Speakers



UHC-30XT
30W/100V

UHC-25XT
25W/100V

UHC-15XT
15W/100V



SUH-40XT
40W/100V

SUH-25XT
25W/100V

SUH-15XT
15W/100V

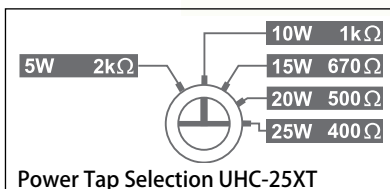

- Ahuja high quality, weather proof horn speakers are compact, light weight and rugged. They are moulded in tough UV protected ABS plastic for longer lasting finish.
- The specifications and construction of these are similar to the low impedance horn speakers. These models have been provided with 100V line matching transformers with multiple taps/impedance easily selectable by changing the position of the rotary switch at the rear of the sealed assembly.
- These 100V models are ideal for installations where long speaker cables are used, to avoid power loss in the cables.
- Rectangular models are particularly suitable for areas where directivity of sound is of importance.
- They meet European Union regulations and comply with low voltage directive standard EN 60065. Degree of protection IP 66 is provided against foreign particles such as dust and jets of water, thus making them ideal for outdoor use.

UV Protected ABS Bell, Reflector and Back Cover. External Stand Mounting Bolts in Stainless Steel

SPECIFICATIONS	UHC-30XT	UHC-25XT	UHC-15XT	SUH-40XT	SUH-25XT	SUH-15XT
INPUT POWER	30W RMS/45W Max.	25W RMS/38W Max.	15W RMS/23W Max.	40W RMS/60W Max.	25W RMS/38W Max.	15W RMS/23W Max.
POWER TAPS	30/25/20/15/10/5W	25/20/15/10/5W	15/10/5/2.5W	40/30/20/10/5W	25/20/15/10/5W	15/10/5/2.5W
IMPEDANCE	330/400/500/670/ 1k/2kΩ	400/500/670/ 1k/2kΩ	670/1k/2k/4kΩ	250/330/500/ 1k/2kΩ	400/500/670/ 1k/2kΩ	670/1k/2k/4kΩ
FREQUENCY RESPONSE	240-10,000Hz	250-10,000Hz	275-7,000Hz	180-7,000Hz	250-10,000Hz	275-7,000Hz
SPL at 1kHz	108dB/1W/1m 123dB/30W/1m	108dB/1W/1m 122dB/25W/1m	106dB/1W/1m 118dB/15W/1m	112.5dB/1W/1m 128.5dB/40W/1m	108dB/1W/1m 122dB/25W/1m	106dB/1W/1m 118dB/15W/1m
DIMENSIONS	ø313 (L315) mm	ø274 (L310) mm	ø205 (L270) mm	400 x 200 (L422) mm	315 x 165 (L320) mm	253 x 152 (L293) mm
WEIGHT	2.39kg	2.34kg	1.78kg	3.90kg	2.30kg	1.89kg
MATERIAL	ABS (UV Protected)	ABS (UV Protected)	ABS (UV Protected)	ABS (UV Protected)	ABS (UV Protected)	ABS (UV Protected)

AMH-402T 40 WATTS



Ahuja introduces AMH-402T, a 2-way high efficiency, high fidelity PA Music Horn Speaker. It uses a 15.24 cm (6") Kevlar cone woofer and a 2.54 cm (1") phenolic dome tweeter. Thus it combines the high efficiency of a horn with the wide frequency response obtained by using a 2-way woofer tweeter combination. Housed in a beautifully designed UV protected ABS plastic housing, the music horn is weather protected which makes it ideal for outdoor as well as indoor applications.

- Unique concept used to create a well-engineered 2-way PA Music Horn with high efficiency, long throw, and wide frequency response.
- Sound quality of exceptional richness, clarity and fidelity. Ideal for music as well as announcements.
- Rugged & sturdy construction with aesthetically superior finish. UV protected ABS plastic housing.
- Comprises of a highly efficient 15.24 cm (6") Kevlar cone LF driver and a 2.54 cm (1") HF driver for wider frequency response and higher SPL.
- Easy power tap selection on a terminal strip with a 2-core cable.
- Strong mounting bracket for rigid mounting.

Ideal for both Indoor and Outdoor applications

Railway Stations... Educational Institutions... Religious Places... Stadiums... Amusement Parks...
Factories... Cruise Liners... etc.

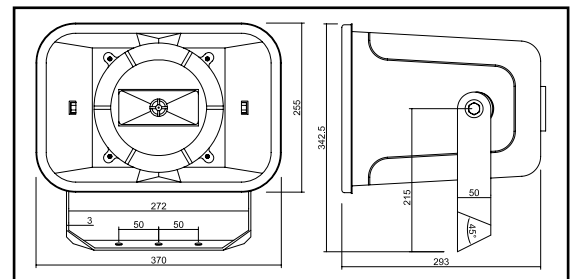
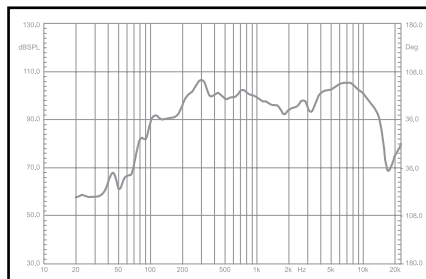

SPECIFICATIONS

AMH-402T

INPUT POWER	40W RMS
POWER TAPS	40/20/10/5W
IMPEDANCE	250/500/1k/2kΩ
FREQUENCY RESPONSE	120-16,000Hz
SPL at 1kHz	98dB/1W/1m; 114dB/40W/1m
DIMENSIONS	W370 × H255 × D300 mm
WEIGHT	5.90kg
MATERIAL	ABS (UV Protected)



PA Horns

WFA, WFB PA Reflex Horns



AHUJA heavy duty aluminium horns are ideal for many large outdoor installations. Rugged construction and fitted with a protective PVC ring on the flare.

Acoustically well designed, these match Ahuja driver units for an efficient, powerful and clear sound.

SPECIFICATIONS	WFA	WFB
BELL DIA	533.4 mm (21")	457.2 mm (18")
CUT-OFF FREQUENCY	160Hz	190Hz
WEIGHT	2.17kg	1.87kg

ATH-22 PA Trumpet Horn



Rugged Ahuja Trumpet Horn, specially made for high efficiency, optimum frequency response and long throw. Suitable for all Ahuja Driver Units.

SPECIFICATIONS	ATH-22
BELL DIA	588.8 mm (22")
CUT-OFF FREQUENCY	160Hz
WEIGHT	2.27kg

DIAPHRAGMS



AU-35/AU-40/AU-60



AU-40XT/AU-50XT

The high quality diaphragms used in AHUJA Driver Units are specially shaped, reinforced phenolic diaphragms with a precision-wound voice coil on ALUMINIUM former for good heat dissipation. The rigid assembly offers high acoustic properties and is most indestructible in normal service. The self-centering design requires little skill to replace the diaphragm.

SCM-30®
20W/16Ω

SCM-30®T
20W/100V

PA Column Speakers

SCM SERIES

- For Indoor & Outdoor applications such as in Halls, Auditoria, Airport Lounges.
- Weather resistant — for use under roof eaves. Foam layer to protect speakers from dust.
- Array of speakers radiate forward sound beam for wider audience coverage.
- Mounting clamps & hardware supplied.

SCM-30®/SCM-30®T SCM-15/SCM-15T

- Column speakers in metal cabinet in powder coated finish.
- Speaker connections through a terminal strip at the rear.
- Available in 100V line matching transformer version and low impedance version.

SCM-15
10W/8Ω

SCM-15T
10W/100V



SPECIFICATIONS	SCM-15/SCM-15T	SCM-30®/SCM-30®T
INPUT POWER	10W RMS 15W Max.	20W RMS 30W Max.
POWER TAPS	10W, 10/7.5/5W	20W, 20/15/10W
IMPEDANCE/VOLTAGE	8Ω, 100V	16Ω, 100V
FREQUENCY RESPONSE	150-10,000Hz	150-10,000Hz
SPL at 1kHz	92dB/1W/1m	95dB/1W/1m
SPEAKERS	2 × 152.4 mm (6") × 101.6 mm (4")	4 × 152.4 mm (6") × 101.6 mm (4")
DIMENSIONS	W165 × H455 × D145 mm	W165 × H885 × D145 mm
WEIGHT	2.83kg 2.85kg	5.50kg 6.07kg

ASC SERIES

- For Indoor & Outdoor applications such as in Halls, Auditoria, Airport Lounges.
- Weather resistant — for use under roof eaves. Foam layer to protect speakers from dust.
- Array of speakers radiate forward sound beam for wider audience coverage.
- Mounting clamps & hardware supplied.



ASC-310T/ASC-315T/ ASC-320T

- Slim, compact, aesthetically designed column speakers.
- Off-white colour to integrate with most interiors.
- Aluminium extruded cabinet with moulded plastic covers, metal mesh grille.
- 100V line matching transformer with rotary switch for power tap selection.

ASC-20T/ASC-40T

- Column speakers in grey colour for indoor & outdoor applications.
- Aluminium extruded cabinet with moulded plastic covers. Metal mesh grille in black colour.
- 100V transformer with rotary switch for power tap selection.

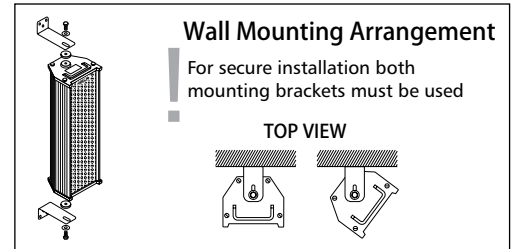

ASC-40T
30W/100V

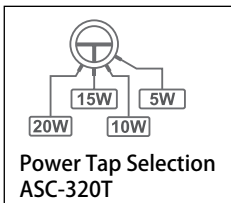
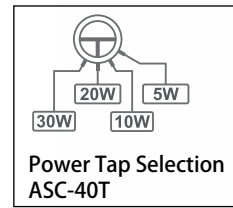

SPECIFICATIONS	ASC-310T	ASC-315T	ASC-320T	ASC-20T	ASC-40T
INPUT POWER	10W RMS 15W Max.	15W RMS 23W Max.	20W RMS 30W Max.	15W RMS 23W Max.	30W RMS 45W Max.
POWER TAPS	10/7.5/5/2.5W	15/10/5/2.5W	20/15/10/5W	15/10/5/2.5W	30/20/10/5W
IMPEDANCE/VOLTAGE	100V	100V	100V	100V	100V
FREQUENCY RESPONSE	150-15,000Hz	150-15,000Hz	150-15,000Hz	150-10,000Hz	150-10,000Hz
SPL at 1kHz	90dB/1W/1m	91.5dB/1W/1m	93dB/1W/1m	92dB/1W/1m	95dB/1W/1m
SPEAKERS	2 × 127mm (5") × 76.2mm (3")	3 × 127mm (5") × 76.2 (3")mm	4 × 127mm (5") × 76.2 mm (3")	2 × 152.4mm (6") × 101.6mm(4")	4 × 152.4mm(6") × 101.6mm(4")
DIMENSIONS	W115 × H389 × D89 mm	W115 × H524 × D89 mm	W115 × H658 × D89 mm	W145 × H460 × D130 mm	W145 × H900 × D130 mm
WEIGHT	1.90kg	2.50kg	3.10kg	2.70kg	5.10kg



CS-451T

Compact ceiling speaker with clamps to flush mount without screws.

- 12.7 cm (5") Full Range Speaker, 4W/100V.
- Easy mounting with spring loaded wing clamps.
- Stylish plastic grille in white colour.
- Ideal for **Speech and Music in Hotels... Restaurants... Offices...**

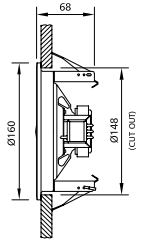

CS-663T

High quality flush mount ceiling speaker.

- 15.24 cm (6") Full Range Speaker, 6W/100V.
- Easy selection of power taps through change of receptacle on 100V LMT.
- Aesthetically designed plastic grille and easy mounting with spring loaded clamps.
- Ideal for **Hotels... Shopping Malls... Offices...**

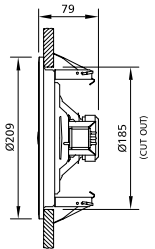

CS-662T

High quality flush mount ceiling speaker for indoor public address and background music installations. Screw mounting grille.

- 15.24 cm (6") Full Range Speaker, 6W/100V.
- ABS plastic grille with attractive design.
- Easy selection of power taps through change of receptacle on 100V LMT.
- Ideal for **Hotels... Shopping Malls... Offices...**

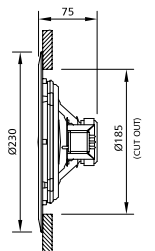

BS-6462T

Metal box speaker for sound system installations in Railway Coaches, Industrial Establishments etc., Powder coated sturdy metal enclosure. Vandal-proof.

- 15.24 cm (6") × 10.16 cm (4") Full Range Speaker, 6W/100V.
- Can be wall mounted also. Key holes provided on rear.

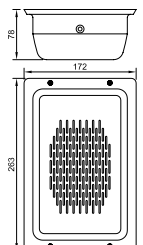

SPECIFICATIONS	CS-451T	CS-663T	CS-662T	BS-6462T
INPUT POWER	4W RMS	6W RMS	6W RMS	6W RMS
POWER TAPS ON 100V	4/2/1W	6/3/1.5W	6/3/1.5W	6/3/1.5W
IMPEDANCE	2.5k/5k/10kΩ	1.6k/3.3k/6.6kΩ	1.6k/3.3k/6.6kΩ	1.6k/3.3k/6.6kΩ
FREQUENCY RESPONSE	80-15,000Hz	60-15,000Hz	60-15,000Hz	150-10,000Hz
SPL at 1kHz (1W/1m)	92dB	92dB	92dB	91dB
DIMENSIONS	∅160 × H68 mm	∅209 × H79 mm	∅230 × H75 mm	W172 × H263 × D78 mm
WEIGHT	640g	835g	670g	1.40kg



CS-3061T

Attractive, compact ceiling speaker with excellent clarity and intelligibility. Moulded ABS plastic frame with spring mounting clamps.

- 7.62 cm (3") Full Range Speaker, 6W/100V
- 100V line operation with easy power tap selection through a terminal block
- Superbly engineered for simple and safe installation
- Ideal for [offices...](#) [Restaurants...](#) [Hospitals...](#) [Shopping Malls...](#) [Gymnasiums...](#)

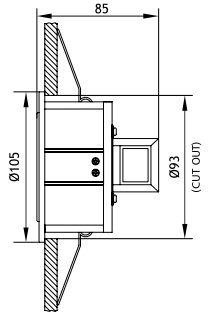

CS-5061T

High quality flush mount ceiling speaker with stylish grill and frame, which integrates wonderfully well with all interiors. Clear and clean sound for speech and music.

- 12.7 cm (5") Full Range Speaker, 6W/100V.
- Beautiful powder coated aluminium mesh grille and moulded plastic frame.
- 100V line operation with easy power tap selection through a terminal block.
- Superbly engineered for simple and safe installations.
- Ideal for [Offices...](#) [Restaurants...](#) [Hospitals...](#) [Shopping Malls...](#) [Hotels...](#) [Gymnasiums...](#)

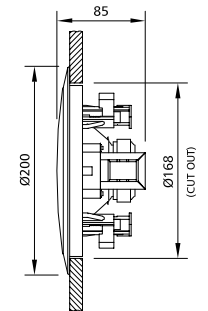

CS-6081T

High quality flush mount ceiling speaker with an elegant grill and frame, which integrates wonderfully well with all interiors. Clear and crisp sound for speech and music.

- 15.24 cm (6") Full Range Speaker, 8W/100V.
- Beautiful powder coated aluminium mesh grille and moulded plastic frame.
- Power tap selection on 100V through female receptacle (push fit).
- Superbly engineered for simple and safe installations.
- Ideal for [Offices...](#) [Restaurants...](#) [Hospitals...](#) [Shopping Malls...](#) [Hotels...](#) [Gymnasiums...](#)

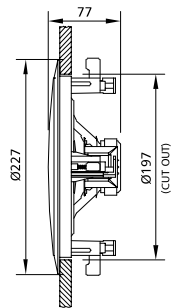

CS-8151T

High quality flush mount ceiling speaker with attractive grill and frame, which integrates very well with all interiors. Outstanding sound quality.

- 20.32 cm (8") Dual Cone Full Range Speaker, 15W/100V.
- High fidelity and excellent frequency response.
- 100V line operation with easy power tap selection through a terminal block.
- Superbly engineered for simple and safe installations.
- CS-8151T is a right choice for HIGH CEILING.
- Ideal for [Offices...](#) [Restaurants...](#) [Hotels...](#) [Hospitals...](#) [Shopping Malls...](#) [Gymnasiums...](#)

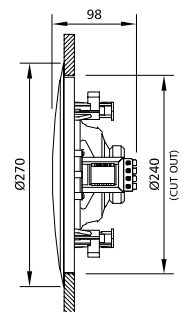

SPECIFICATIONS	CS-3061T	CS-5061T	CS-6081T	CS-8151T
INPUT POWER	6W RMS	6W RMS	8W RMS	15W RMS
POWER TAPS ON 100V	6/3/1.5W	6/3/1.5W	8/4/2W	15/10/5W
IMPEDANCE	1.6k/3.3k/6.6kΩ	1.6k/3.3k/6.6kΩ	1.25k/2.5k/5kΩ	670/1k/2kΩ
FREQUENCY RESPONSE	65-15,000Hz	60-15,000Hz	60-15,000Hz	55-16,000Hz
SPL at 1kHz (1W/1m)	88dB	92dB	92dB	93dB
DIMENSIONS	Ø105 × H85 mm	Ø200 × H85 mm	Ø227 × H77 mm	Ø270 × H98 mm
WEIGHT	410g	750g	780g	1.40kg



CSX-3081T

Attractive, ultra modern rimless design 8 watts ceiling speaker with excellent sound quality. The elegant, low profile design.

- 7.62 cm (3") Full Range Speaker with power taps of 8/4/2W.
- 8 Watts continuous power handling capacity.
- Easy mounting with spring mounting clamps.
- 100V operation with easy selection of power taps.
- Ideal for Offices... Restaurants... Hotels... Hospitals... Shopping Malls... Gymnasiums...

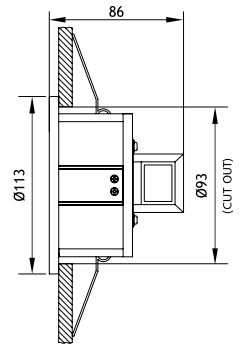

CSX-5081T

Elegant, low profile rimless ceiling speaker with clear, highly intelligible sound. Low profile appearance.

- 12.7 cm (5") Full Range Speaker with power taps of 8/4/2W.
- 8 Watts continuous power handling capacity
- Easy mounting with spring loaded wing clamps.
- 100V operation with easy selection of power taps through a terminal block.
- Ideal for Offices... Restaurants... Hotels... Hospitals... Shopping Malls... Gymnasiums...

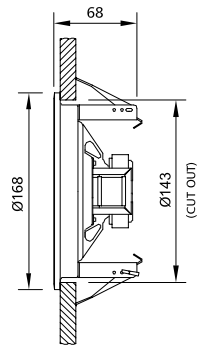

CSX-6101T

Ceiling speaker with an elegant, aesthetically pleasing rimless design. Excellent sound quality combined with an ultra-modern low profile appearance makes this ideally suited for high-end offices, restaurants, bars, malls etc.

- 15.24 cm (6") Full Range Speaker with power taps of 10/5/2.5W.
- 10 Watts continuous power handling capacity.
- Easy mounting with spring loaded wing clamps.
- 100V operation with easy selection of power taps through a terminal block.
- Ideal for Offices... Restaurants... Hotels... Hospitals... Shopping Malls... Gymnasiums.....

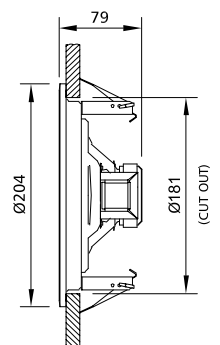

SPECIFICATIONS	CSX-3081T	CSX-5081T	CSX-6101T
INPUT POWER	8W RMS	8W RMS	10W RMS
POWER TAPS ON 100V	8/4/2W	8/4/2W	10/5/2.5W
IMPEDANCE	1.25k/2.5k/5kΩ	1.25k/2.5k/5kΩ	1k/2k/4kΩ
FREQUENCY RESPONSE	65-15,000Hz	80-15,000Hz	60-15,000Hz
SPL at 1kHz (1W/1m)	88dB	92dB	92dB
DIMENSIONS	ø113 × H86 mm	ø168 × H68 mm	ø204 × H79 mm
WEIGHT	450g	700g	910g



2
WAY

CSD-5201T

High power 2-way flush mount ceiling speaker for excellent reproduction of both speech and music. Wide frequency response and adjustable tweeter for optimum directivity.

- Operates on 100V line with power taps of 20/10/5W.
- Moulded plastic frame with metal mesh grill.
- Tweeter can be tilted at an angle to focus clear, intelligible sound in the desired direction.
- 100V line operation with easy power tap selection through a terminal block.
- Ideal for **Hotels**... **Office Buildings**... **Restaurants**... **Hospitals**... **Shopping Malls**... **Department Stores**... **Cinemas**... **Gyms**...

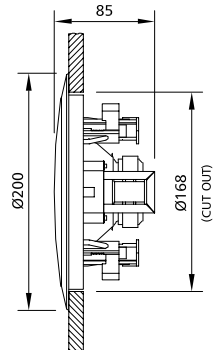

2
WAY

CSD-6303T

High power 2-way flush mount ceiling speaker for excellent reproduction of both speech and music. Wide frequency response and adjustable tweeter for optimum directivity.

- Operates on 100V line with power taps of 30/15/7.5W.
- Moulded plastic frame with metal mesh grill.
- Tweeter can be tilted at an angle to focus clear, intelligible sound in the desired direction.
- 100V line operation with easy power tap selection through a terminal block.
- Ideal for **Hotels**... **Office Buildings**... **Restaurants**... **Hospitals**... **Shopping Malls**... **Department Stores**... **Cinemas**... **Gyms**...

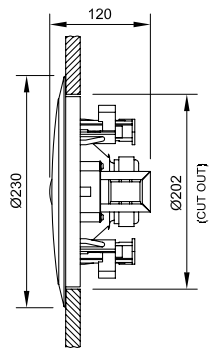

2
WAY

CSD-8401T

High power 2-way flush mount ceiling speaker for excellent reproduction of both speech and music. Adjustable tweeter enables high frequencies to be directed wherever they are most required.

- Operates on 100V line with power taps of 40/20/10W.
- Moulded plastic frame with metal mesh grill.
- 20.32 cm (8") woofer and adjustable 2.54 cm (1") tweeter.
- 100V line operation with easy power tap selection through a terminal block.
- Ideal for **Hotels**... **Office Buildings**... **Restaurants**... **Hospitals**... **Shopping Malls**... **Department Stores**... **Cinemas**... **Gyms**...

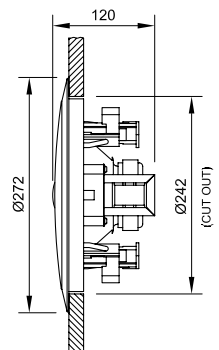

SPECIFICATIONS	CSD-5201T	CSD-6303T	CSD-8401T
INPUT POWER	20W RMS	30W RMS	40W RMS
POWER TAPS ON 100V	20/10/5W	30/15/7.5W	40/20/10W
IMPEDANCE	500/1k/2kΩ	330/670/1.33kΩ	250/500/1kΩ
FREQUENCY RESPONSE	90-18,000Hz	90-18,000Hz	90-18,000Hz
SPL at 1kHz (1W/1m)	91dB	92dB	93dB
SPEAKER	Woofer 150mm (5") Tweeter 25mm (1")	Woofer 150mm (6") Tweeter 25mm (1")	Woofer 200mm (8") Tweeter 25mm (1")
DIMENSIONS	ø200 × H85 mm	ø230 × H120 mm	ø272 × H120 mm
WEIGHT	1.36kg	1.65kg	2.10kg



WSX-551T

High quality, compact and aesthetically designed wall mounting box speaker to suit interiors as in Schools, Offices, BPOs, Hospitals, Banks, Restaurants, Showrooms and Hotels. Clear and clean sound for speech and music.

- 12.7 cm (5") Full Range Wall Speaker in elegant white ABS cabinet, 5W/100V.
- Power tap selection on 100V through female receptacle (push fit).
- Key hole for easy mounting.
- Screw mounting provided from front to make it vandal-proof.

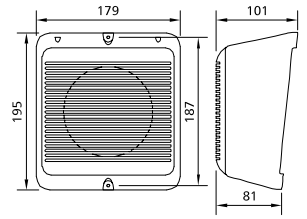

WS-661T/WS-664T

High quality ABS wall mounting box speaker for indoors; speech & background music. For Schools, Offices, BPOs, Hospitals, Banks, Restaurants, Showrooms and Hotels.

- 15.24 cm (6") Full Range Speaker, 6W/100V.
- Key holes for easy wall mounting.
- Power tap selection on 100V through female receptacle (push fit).
- WS-664T has an additional 12 position rotary switch for desired sound level attenuation.

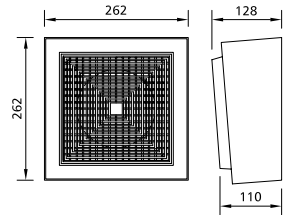

WS-6255T

High power ABS wall mounting box speaker in grey colour for indoor public address and background music in locations of high ambient noise. Ideal for Schools, Hospitals, Canteens, Colleges, Railway Platforms and Hostels.

- 16.51 cm (6.5") Full Range Speaker provides clear and clean sound for both speech and music; 25W/100V.
- Key holes for easy wall mounting.
- Power tap selection on 100V through terminal strip.

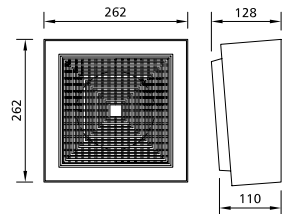

BS-6082T/BS-6083T

Stylish & rugged metal box speaker for a variety of speech & background music applications such as Railway Coaches, Industrial Establishments, Schools, Warehouses, Public Buildings etc. Powder coated metal enclosure.

- Vandal-proof metal cabinet in ivory colour.
- 15.24 cm (6") Full Range Speaker, 8W/100V.
- Key holes for easy wall mounting.
- BS-6082T is wall mount version.
- BS-6083T is for both wall & ceiling mounting.
- Easy power tap selection through terminal strip.

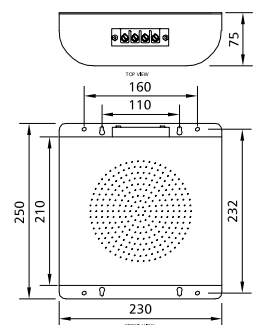

SPECIFICATIONS	WSX-551T	WS-661T/WS-664T	WS-6255T	BS-6082T/BS-6083T
POWER RATING	5W RMS/7.5W Max.	6W RMS/9W Max.	25W RMS/37.5W Max.	8W RMS/12W Max.
POWER TAPS ON 100V	5/2.5/1.25W	6/3/1.5W	25/15/10/5W	8/4/2W
IMPEDANCE	2k/4k/8kΩ	1.6k/3.3k/6.6kΩ	400/670 /1k/2kΩ	1.25k/2.5k/5kΩ
FREQUENCY RESPONSE	80-15,000Hz	60-15,000Hz	120-15,000Hz	60-15,000Hz
SPL at 1kHz (1W/1m)	92dB	92dB	94dB	92dB
DIMENSIONS	W179 × H195 × D101 mm	W262 × H262 × D128 mm	W262 × H262 × D128 mm	W230 × H230 × D75 mm/ W230 × H250 × D75 mm
WEIGHT	740g	1.19kg/1.25kg	1.76kg	1.80kg

2-Way Compact PA Wall Speakers



PS-300T
10 WATTS

- High fidelity 2-Way, 100V multi purpose PA Wall Speaker.
- 100V, Power taps of 6W, 3W & 1.5W
- Power taps can be selected through rotary switch.
- Facility to use as 8 ohms Low Impedance Speaker available.
- Key hole for easy wall mounting.
- Threaded brass ferrule for stand mounting.



PS-400T
16 WATTS

- High fidelity 2-Way, 100V multi purpose PA Wall Speaker.
- 100V Power taps of 16W, 8W & 4W.
- Power taps can be selected through rotary switch.
- Facility to use as 8 ohms Low Impedance Speaker available.
- Weather Resistant Speaker.
- Movable mounting bracket supplied, can be mounted in vertical or horizontal positions.



PS-500T
32 WATTS

- High fidelity 2-Way, 100V multi purpose PA Wall Speaker.
- 100V, Power taps of 32W, 16W, 8W.
- Facility to use as 8 ohms Low Impedance Speaker available.
- Power Taps can be selected through an easily accessible rotary switch.
- Weather Resistant Speaker.
- Movable mounting bracket supplied, can be mounted in vertical or horizontal positions.

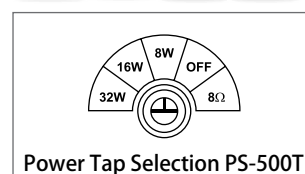
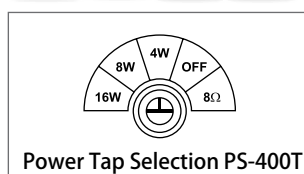
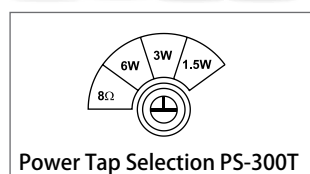

COMMON FEATURES

- High Fidelity sound for music.
- Speaker consists of woofer & dome tweeter.
- Elegant plastic cabinet in white colour.
- Ideal for background music in offices, banks, restaurants, showrooms etc.

SPECIFICATIONS	PS-300T	PS-400T	PS-500T
POWER RATING	10W RMS / 15W Max.	16W RMS / 24W Max.	32W RMS / 48W Max.
RATED VOLTAGE	100V	100V	100V
POWER TAPS ON 100V	6/3/1.5W	16/8/4W	32/16/8W
LOW IMPEDANCE	8Ω	8Ω	8Ω
FREQUENCY RESPONSE	150-20,000Hz	85-20,000Hz	80-20,000Hz
SPL at 1kHz (1W/1m)	86dB	86dB	87dB
SPEAKER	Woofer 75mm (3"), Tweeter 13mm dome	Woofer 95mm (3¾"), Tweeter 13mm dome	Woofer 125mm (5"), Tweeter 13mm dome
DIMENSIONS	W95 × H141 × D100 mm	W133 × H187 × D107 mm	W178 × H252 × D144 mm
WEIGHT	800g	1.42kg	2.65kg

2-Way Compact PA Wall Speakers



ASX-312B/312BT ASX-312W/312WT 30 WATTS

- High fidelity 2-Way PA Wall Speaker in compact & attractive Black or White plastic housing. The suffix B & BT denote Black cabinet, and W & WT denote White cabinet.
- Comprises of a Water Resistant PP coated cone Woofer, a Titanium Dome Tweeter and a 2-way Crossover Network.
- ASX-312B and ASX-312W are low impedance 8Ω speakers.
- ASX-312BT and ASX-312WT are meant for use on 100V line with power taps of 30W, 20W, 15W, 10W & 5W.
- Easy power tap selection through a slotted rotary switch knob at the rear.
- 'U' type bracket for convenient & firm mounting of the wall speaker.
- Ideal for various background music & general PA application.

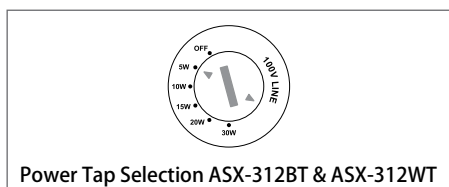

ASX-612B/612BT ASX-612W/612WT 60 WATTS

- High fidelity 2-Way PA Wall Speaker in compact & attractive Black or White plastic housing. The suffix B & BT denote Black cabinet, and W & WT denote White cabinet.
- Comprises of a Water Resistant PP coated cone Woofer, a Titanium Dome Tweeter and a 2-way Crossover Network.
- ASX-612B and ASX-612W are low impedance 8Ω speakers.
- ASX-612BT and ASX-612WT are meant for use on 100V line with power taps of 60W, 40W, 30W, 20W & 10W.
- Easy power tap selection through a slotted rotary switch knob at the rear.
- 'U' type bracket for convenient & firm mounting of the wall speaker.
- Ideal for various background music & general PA application.

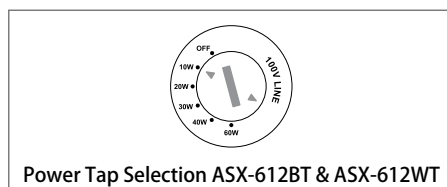

ASX-912B/912BT ASX-912W/912WT 90 WATTS

- High fidelity 2-Way PA Wall Speaker in compact & attractive Black or White plastic housing. The suffix B & BT denote Black cabinet, and W & WT denote White cabinet.
- Comprises of a Water Resistant PP coated cone Woofer, a Titanium Dome Tweeter and a 2-way Crossover Network.
- ASX-912B and ASX-912W are low impedance 8Ω speakers.
- ASX-912BT and ASX-912WT are meant for use on 100V line with power taps of 90W, 60W, 30W & 15W.
- Easy power tap selection through a slotted rotary switch knob at the rear.
- 'U' type bracket for convenient & firm mounting of the wall speaker.
- Ideal for various background music & general PA application.

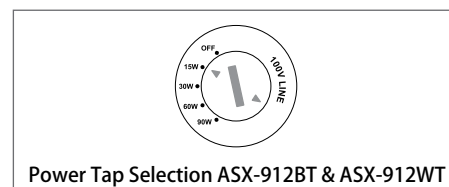

- Black Cabinet (B & BT) ■ White Cabinet (W & WT)

SPECIFICATIONS	ASX-312B/312BT	ASX-612B/612BT	ASX-912B/912BT
POWER RATING	30W RMS/45W Max.	60W RMS/90W Max.	90W RMS / 135W Max.
POWER TAPS	30W, 30/20/15/10/5W	60W, 60/40/30/20/10W	90W, 90/60/30/15W
IMPEDANCE/VOLTAGE	8Ω / 100V	8Ω / 100V	8Ω / 100V
FREQUENCY RESPONSE	75-20,000Hz	50-20,000Hz	55-20,000Hz
SPL at 1kHz (1W/1m)	87dB	87dB	90dB
SPEAKER	Woofer 100mm (4"), Tweeter 25mm (1")	Woofer 163mm (6 1/2"), Tweeter 25mm (1")	Woofer 200mm (8"), Tweeter 25mm (1")
DIMENSIONS	W180 × H248 × D140 mm	W215 × H310 × D175 mm	W270 × H378 × D200 mm
WEIGHT	2.45kg/2.92kg	3.22kg/3.80kg	4.97kg/6.30kg

2-Way Compact PA Wall Speakers



SMX-302T 30 WATTS

- High fidelity 2-Way PA Wall Speaker in compact & elegant black plastic housing.
- Comprises of a Polypropylene Woofer, a Titanium Dome Tweeter and a Crossover Network.
- SMX-302T is meant for use on 100V line with power taps of 30W, 15W & 7.5W.
- Easy power tap selection through a slotted rotary switch knob at the rear.
- 'U' type bracket for convenient wall mounting of the speaker.
- Ideal for various background music & general PA application.

SMX-602T 60 WATTS

- High fidelity 2-Way PA Wall Speaker in compact & elegant black plastic housing.
- Comprises of a Polypropylene Woofer, a Titanium Dome Tweeter and a Crossover Network.
- SMX-602T is meant for use on 100V line with power taps of 60W, 30W & 15W.
- Easy power tap selection through a slotted rotary switch knob at the rear.
- 'U' type bracket for convenient wall mounting of the speaker.
- Ideal for various background music & general PA application.

SMX-902T 90 WATTS

- High fidelity 2-Way PA Wall Speaker in compact & elegant black plastic housing.
- Comprises of a Polypropylene Woofer, a Titanium Dome Tweeter and a Crossover Network.
- SMX-902T is meant for use on 100V line with power taps of 90W, 60W & 30W.
- Easy power tap selection through a slotted rotary switch knob at the rear.
- 'U' type bracket for convenient wall mounting of the speaker.
- Ideal for various background music & general PA application.

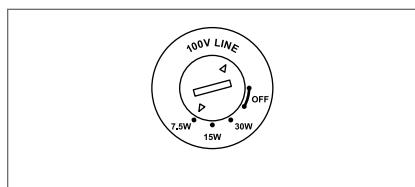

Power Tap Selection

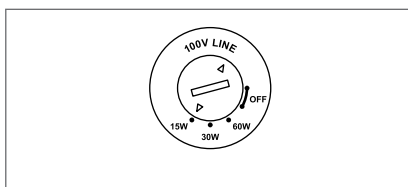

Power Tap Selection

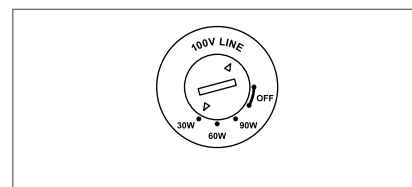

Power Tap Selection

SPECIFICATIONS	SMX-302T	SMX-602T	SMX-902T
POWER RATING	30W RMS/45W Max.	60W RMS/90W Max.	90W RMS/135W Max.
POWER TAPS	30/15/7.5W	60/30/15W	90/60/30W
VOLTAGE	100V	100V	100V
FREQUENCY RESPONSE	80-20,000Hz	55-20,000Hz	55-20,000Hz
SPL at 1kHz (1W/1m)	86dB	88dB	90dB
SPEAKER	Woofer 100mm (4"), Tweeter 25mm (1")	Woofer 163mm (6 1/2"), Tweeter 25mm (1")	Woofer 200mm (8"), Tweeter 25mm (1")
DIMENSIONS	W165 × H225 × D150 mm	W230 × H300 × D200 mm	W280 × H380 × D220 mm
WEIGHT	2.50kg	3.65kg	5.70kg



PA Sound Projector



SP-5251T

Compact & elegant controlled directivity sound projector in aesthetically beautiful white plastic cabinet. Water resistant speaker used in SP-5251T is suitable for outdoor applications also.

- 11.43 cm (4½") Full Range Speaker, 25W/100V.
- Easy power tap selection through a rotary switch.
- 'U' type powder coated mounting bracket
- Ideal for **Factories**... **Hospitals**... **Hotels**... **Schools**... **Railway Platforms**...

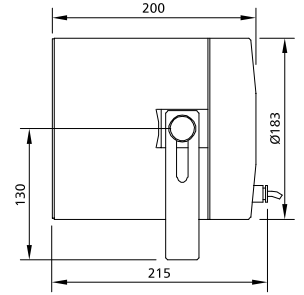

PA Dual Sound Projector



SP-6305TD

Compact & weather resistant bi-directional projection speaker in aesthetically pleasing white plastic cabinet. Creates uniform ambience of sound in a wider area from a single sound source.

- IP-44 degree of dust and water protection.
- 2 × 16.51 cm (6½") Full Range water resistant speakers facing in opposite direction, 30W/100V.
- 'U' type mounting bracket for easy & trouble free installation.
- Ideal for **Railway Platforms**... **Factories**... **Parking Lots**... **School Corridors**... **Theme Parks**...

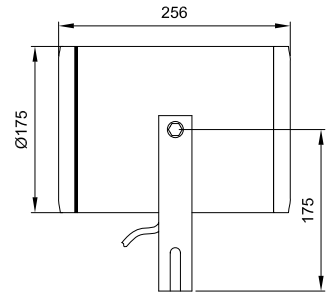

PA Garden Speaker



GS-6401T

Rugged & beautiful green garden speaker which harmoniously merges with the outdoor garden environment. Fitted with two nos. of wide response and water resistant polypropylene speakers. Strong aluminium alloy housing permits various outdoor applications.

- 2 × 12.7 cm (5") Full Range Speakers; 40W/100V
- Power tap selection through different colour wires.
- Ideal for **Gardens**... **Hotels**... **Farm Houses**... **Theme Parks**... **Lawns of Religious Places**... **Historical Monuments**...

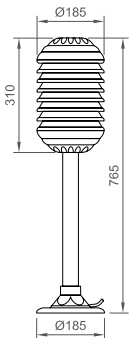

SPECIFICATIONS	SP-5251T	SP-6305TD	GS-6401T
INPUT POWER	25W RMS	30W RMS	40W RMS
POWER TAPS ON 100V	25/20/15/10/5W	30/20/10/5W	40/20/10/5W
IMPEDANCE	400/500/670/1k/2kΩ	330/500/1k/2kΩ	250/500/1k/2kΩ
FREQUENCY RESPONSE	120-15,000Hz	120-15,000Hz	160-16,000Hz
SPL at 1kHz (1W/1m)	93dB	94dB	88dB
DIMENSIONS	Ø183 × H215 mm	Ø175 × H256 mm	Ø185 × H765 mm
WEIGHT	2.10kg	2.60kg	5.2kg

OSX-666T 60 WATTS



Reliable IP-66 rated, weather resistant plastic cabinet wall speaker with outstanding sound clarity. Suitable for both indoor and outdoor use. Suitable for use on 100V line, or on direct 8Ω impedance.

- Comprises of a Polypropylene Cone Woofer, a Titanium Silk Dome Tweeter and a Crossover Network.
- Power taps can be selected through a slotted rotary switch knob at the rear, accessible after removing the terminal cover.
- 'U' type metal bracket for firm mounting and optimum positioning of the wall speaker.

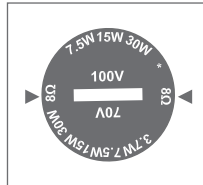

Power Tap Selection

SPECIFICATIONS	OSX-66T
POWER RATING	60W/ 8 Ω; 30W/ 100V
POWER TAPS ON 100V	30/15/7.5W
FREQUENCY RESPONSE	95-20,000Hz
SPL at 1kHz (1W/1m)	87dB
SPEAKER	Woofer 163mm (6½"), Tweeter 25mm (1.0")
DIMENSIONS	W205 × H330 × D199 mm
WEIGHT	1.31kg



2-Way Outdoor Speaker

Speaker Volume Controllers

AT-06/AT-20/AT-40 Speaker Volume Control

An elegant and compact volume controller for 100V line signals. It enables the user to conveniently adjust the volume of a speaker or group of speakers. It is available in three power ratings of 40W, 20W and 6W.

- Attractive, aesthetically pleasing white plastic housing.
- Simple to install against walls, partitions and panels, even after the installation wiring is complete.
- Compatible with all Ahuja wall and ceiling speakers which have 100V line matching transformer.
- Reliable, high wattage rotary switch (in AT-40 and AT-20) has 11 selectable positions: Max, 9 attenuated positions (in 3 dB steps) & OFF.
- AT-06 has a reliable rotary switch with 5 selectable positions: Max, 3 attenuated positions (in 3dB steps) & OFF.
- Suitable for connection to speaker or speakers with RMS power rating up to 40 Watts (for AT-40), 20 Watts (for AT-20) and 6 Watts (for AT-06).
- Ideal for hotels, office cabins, showrooms, greenrooms, etc.



SPECIFICATIONS	AT-06	AT-20	AT-40
Rated Power	6W RMS	20W RMS	40W RMS
Input Voltage	100V	100V	100V
Output Positions	Max, 3 attenuation positions in 3dB steps (-3dB to -9dB) and OFF	Max, 9 attenuation positions in 3dB steps (-3dB to -27dB) and OFF	Max, 9 attenuation positions in 3dB steps (-3dB to -9dB) and OFF
Dimensions	W87 × H87 × D78 mm	W87 × H87 × D78 mm	W87 × H87 × D78 mm
Weight	150g	250g	250g



SRX-50DX/50XT 50 WATTS

A compact general purpose Loudspeaker column using two Full Range Dual Cone 20.32 cm (8") speakers, reproducing a clean undistorted sound for both speech and music. The system is housed in a Rugged Closed Box Enclosure made of 12mm medium density fibre board, and has a durable black shock resistant paint finish. SRX-50DX has nominal impedance of 16Ω, SRX-50XT operates on 100V line with three power taps selectable through a rotary switch.



SRX-120®DXM 100 WATTS

An elegant and reliable Loudspeaker comprising of a single 30.48 cm (12") Full Range Dual Cone speaker and a Piezo Horn Tweeter. The system is capable of handling 100W continuous power with undistorted response and is ideal for small PA applications. The speakers are housed in a trapezoidal closed box enclosure made of 18mm board, and carpet covered. Fully protected by front grille. Ergonomically designed handles for easy portability. Stand mount adaptor is provided at the bottom.



SRX-200 200 WATTS

Professional 2-Way PA Loudspeaker to provide superb LF Response, High Efficiency and Long Throw with Excellent Sound Intelligibility. It consists of one 30.48 cm (12") Full Range Dual Cone Speaker and a Piezo Horn Tweeter. The system is housed in an acoustically treated Bass Reflex enclosure made of 18mm board, and carpet covered. Stand mount adaptor is provided at the bottom.

SPECIFICATIONS	SRX-50DX	SRX-50XT	SRX-120®DXM	SRX-200
POWER RATING	50W Max.	50W Max.	100W RMS/200W Programme	200W RMS/400W Programme
POWER TAPS	—	30/20/10W at 100V	—	—
CONFIGURATION	One Way	One Way	Two Way	Two Way
FREQUENCY RESPONSE	55-16,000Hz	55-16,000Hz	55-20,000Hz	50-20,000Hz
LOW FREQUENCY SPEAKER	2 x 203.2 mm (8"), Ø19.05mm (0.75") Voice Coil	2 x 203.2 mm (8"), Ø19.05mm (0.75") Voice Coil	1 x 304.8mm (12"), Ø38.1mm (1.5") Voice Coil	1 x 304.8mm (12"), Ø50.8mm (2.0") Voice Coil
HIGH FREQUENCY UNIT	—	—	1 x Piezo Horn Tweeter 2"×5"	1 × Piezo Horn Tweeter 3"×6"
	—	—	50.8mm (2") × 127mm (5")	76.2mm (3") × 152.4mm (6")
SPL at (1W/1m)	96dB	96dB	97 dB	97dB
MAX. RATED SPL	113dB	113dB	117 dB	120dB
NOMINAL IMPEDANCE	16 Ω	333/500/1kΩ	8 Ω	8 Ω
PORT	Sealed Enclosure	Sealed Enclosure	Sealed Enclosure	Free Flow Flared
INPUT CONNECTORS	Two nos. of Terminal Strip in parallel	—	1/4" Phone Jack + Terminal Strip	1/4" Phone Jack + Terminal Strip
DIMENSIONS	W325 × H585 × D240 mm	W325 × H605 × D240 mm	W410 × H530 × D380 mm	W410 × H600 × D430mm
WEIGHT	9.20kg	9.60kg	15.40kg	22.30kg



SRX-220 200 WATTS

Professional 2-Way Loudspeaker with high efficiency, long throw & clean undistorted sound for both speech & music. It consists of one 38.1 cm (15") Full Range Dual Cone Speaker and a Piezo Horn Tweeter. The system is housed in an acoustically treated Bass Reflex Trapezoidal enclosure made of 18mm board, and carpet covered. Stand mount adaptor is provided at the bottom.



SRX-250°DXM 200 WATTS

An aesthetically superior Loudspeaker that combines two 30.48 cm (12") Full Range Dual Cone speakers and a Piezo Horn Tweeter. It delivers the fidelity of sound and the column effect for sound coverage demanded in sound reinforcement and PA applications. The system is housed in a Rugged Trapezoidal Bass Reflex Enclosure made of 18mm board, and Carpet covered. Fully protected by front grille. Ergonomically designed handles for easy portability. Stand mount adaptor is provided at the bottom.



SRX-440 400 WATTS

New high power, high efficiency professional Loudspeaker with well-balanced wide-spectrum sound. Consists of two 30.48 cm (12") Dual Cone Speakers and a Piezo Horn Tweeter fitted in a rugged bass reflex carpet covered enclosure. The cabinet has been fitted with heavy-duty handles to allow ease of transportation and a strong steel grille for speaker protection. A stand adaptor is provided at the bottom for pole mounting. Ideal for DJs, variety music programmes and general PA applications.

SPECIFICATIONS	SRX-220	SRX-250°DXM	SRX-440
POWER RATING	200W RMS/400W Programme	200W RMS/400W Programme	400W RMS/800W Programme
CONFIGURATION	Two Way	Two Way	Two Way
FREQUENCY RESPONSE	50-20,000Hz	55-20,000Hz	50-20,000Hz
LOW FREQUENCY SPEAKER	1 × 381mm (15"), Ø50.8mm (2.0") Voice Coil	2 × 304.8mm (12"), Ø38.1mm (1.5") Voice Coil	2 × 304.8mm (12"), Ø50.8mm (2.0") Voice Coil
HIGH FREQUENCY UNIT	1 × Piezo Horn Tweeter	1 × Piezo Horn Tweeter	1 × Piezo Horn Tweeter
	76.2mm (3") × 152.4mm (6")	76.2mm (3") × 152.4mm (6")	76.2mm (3") × 152.4mm (6")
SPL at (1W/1m)	98dB	100dB	100dB
MAX. RATED SPL	121dB	123dB	126dB
NOMINAL IMPEDANCE	8 Ω	8 Ω	8 Ω
PORT	Free Flow Flared	Free Flow Flared	Free Flow Flared
INPUT CONNECTORS	1/4" Phone Jack + Terminal Strip	1/4" Phone Jack + Terminal strip	1/4" Phone Jack + Terminal strip
DIMENSIONS	W490 × H680 × D415mm	W410 × H860 × D370 mm	W416 × H930 × D430 mm
WEIGHT	26.00kg	25.00kg	33.50kg



PA Cabinet Loudspeakers



SRX-500®
400 WATTS

Professional 2-way Loudspeaker with exceptional efficiency, long throw and unmatched intelligibility of sound. It consists of two 38.1cm (15") high performance full range dual cone speakers and a High frequency compression driver. The speaker system is housed in an acoustically treated Bass Reflex Trapezoidal carpet covered enclosure. The cabinet has been fitted with heavy-duty handles to allow ease of transportation and a strong steel grille for speaker protection. Ideal for both indoor and outdoor sound reinforcement applications. Specially designed for Auditoriums and DJs.



SRX-510
400 WATTS

Professional 2-way Loudspeaker with exceptional efficiency, long throw and unmatched intelligibility of sound. It consists of two 38.1cm (15") high performance full range dual cone speakers and a High frequency compression driver. The speaker system is housed in an acoustically treated Bass Reflex Trapezoidal with durable paint finish enclosure. The cabinet has been fitted with heavy-duty handles to allow ease of transportation and a strong steel grille for speaker protection. Ideal for both indoor and outdoor sound reinforcement applications. Specially designed for Auditoriums and DJs.

SPECIFICATIONS	SRX-500®	SRX-510
POWER RATING	400W RMS/800W Programme	400W RMS/800W Programme
CONFIGURATION	Two Way	Two Way
FREQUENCY RESPONSE	50-20,000Hz	50-20,000Hz
LOW FREQUENCY SPEAKER	2 × 381mm (15"), Ø50.8mm (2.0") Voice Coil	2 × 381mm (15"), Ø50.8 (2.0") Voice Coil
HIGH FREQUENCY UNIT	Dynamic Horn, 101.6mm (4") × 254mm (10")	Dynamic Horn, 101.6mm (4") × 254mm (10")
SPL at (1W/1m)	101dB	101dB
MAX. RATED SPL	127dB	127dB
NOMINAL IMPEDANCE	8Ω	8Ω
CROSSOVER FREQUENCY	6kHz	6kHz
PORT	Free Flow Flared	Free Flow Flared
INPUT CONNECTORS	2 Nos. of Speakon Sockets	2 Nos. of Speakon Sockets
DIMENSIONS	W510 × H1135 × D505 mm	W505 × H1125 × D503 mm
WEIGHT	49.50kg	52.00kg



SQX-850
800 WATTS

Sturdy & rugged carpet covered bass reflex cabinet built around 4 nos high quality 30.48 cm (12") dual cone speakers. Features high efficiency, high sound pressure level, & unmatched bass. Tuned for optimum performance, and having a high power handling capacity of 800 watts RMS, this is an ideal cabinet speaker for large gatherings and for use with high power amplifiers.



SAX-200DX
200 WATTS

Professional 2-Way Loudspeaker consists of one high efficiency 30.48 cm (12") LF speaker and a 2.54 cm (1") HF Compression Driver. The system is housed in a Rugged Bass Reflex Trapezoidal Enclosure made of 18mm board, and Carpet covered. A Stand Adapter at the bottom for stand mounting is also provided. The trapezoidal enclosure construction assures optimum low frequency performance and smoothness with minimum interference from standing waves and box resonance. The speaker produces high sound pressure levels with accuracy in any environment and thus is ideal for all PA and music performances.

SPECIFICATIONS	SQX-850	SAX-200DX
POWER RATING	800W RMS/1600W Programme	200W RMS/400W Programme
CONFIGURATION	One Way	Two Way
FREQUENCY RESPONSE	50-16,000Hz	45-20,000Hz
SPEAKER	4 × 304.8mm (12") Full Range Speaker	1 x 304.8mm (12"), Ø50.8mm (2") Voice Coil
HIGH FREQUENCY UNIT	—	Dynamic Horn, 101.6mm (4") × 254mm (10")
SPL at (1W/1m)	103dB	97dB
MAX. RATED SPL	132dB	119dB
NOMINAL IMPEDANCE	4Ω	8Ω
CROSSOVER FREQUENCY	—	4kHz
PORT	Free Flow Flared	Free Flow Flared
INPUT CONNECTORS	Terminal Strip + Speakon	1/4" Phone Jack + Terminal Strip
DIMENSIONS	W755 × H810 × D525 mm	W510 × H655 × D405 mm
WEIGHT	55.10kg	25.50kg



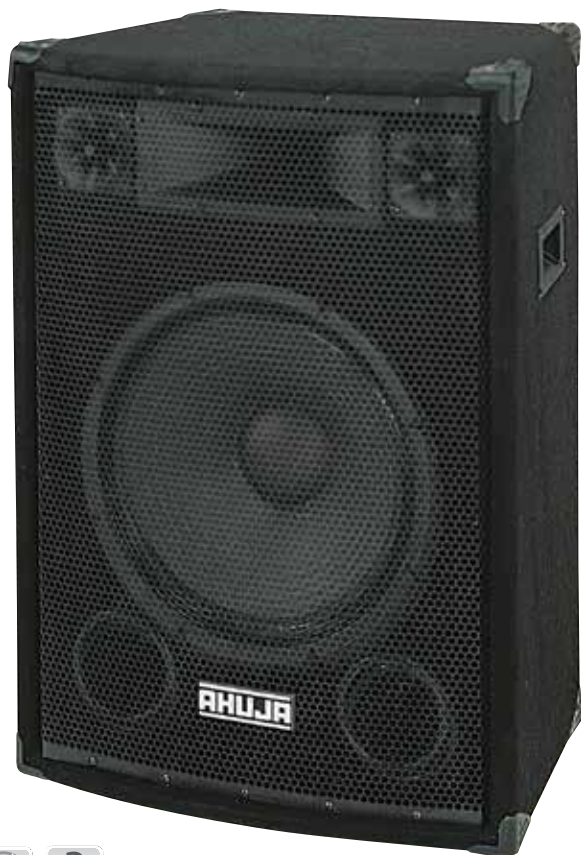

1x15" 3 WAY

SAX-300DX 300 WATTS

Professional 3-Way Loudspeaker consisting of one high efficiency, high SPL 38.1 cm (15") LF speaker, a 2.54 cm (1") HF Compression Driver and two Piezo Tweeters, for excellent high frequency response. The system is housed in a Rugged Bass Reflex Trapezoidal Enclosure made of 18mm board, and Carpet covered. A Stand Adapter is provided at the bottom for stand mounting. The trapezoidal cabinet design assures optimum low frequency performance. An On/Off switch for the piezo speakers is provided to limit extended HF if desired. The speaker is ideal for PA as well as music performances.



1x15" 2 WAY

SPX-400DX 350 WATTS

This 2-Way Loudspeaker combines professional components of superior quality in a proper balanced integrated design, to deliver the fidelity of sound and the coverage demanded in sound reinforcement, outdoor PA and live music applications. The SPX-400DX has been built around the development of an exceptional HF compression driver containing a TITANIUM diaphragm. It also utilizes a high efficiency, high SPL 38.1 cm (15") LF speaker in order to deliver tight and deep bass. It has a built in 2kHz Crossover Network with PTC protection for the HF unit. The system is housed in a Rugged Bass Reflex Trapezoidal Enclosure made of 18mm board, and Carpet covered with a Stand Mount Adapter at the bottom. The cabinet has been fitted with heavy duty handles to allow ease of transportation.

SPECIFICATIONS	SAX-300DX	SPX-400DX
POWER RATING	300W RMS/600W Programme	350W RMS/700W Programme
CONFIGURATION	Three Way	Two Way
FREQUENCY RESPONSE	40-20,000Hz	40-20,000Hz
LOW FREQUENCY SPEAKER	1 x 381mm (15"), Ø76.2mm (3") Edge Wound Voice coil	1 x 381mm (15"), Ø76.2mm (3") Edge Wound Voice Coil
HIGH FREQUENCY UNIT	Dynamic Horn, 101.6mm (4") x 254mm (10") + 2 Piezo Tweeters	Dynamic Horn 177.8mm (7") x 406.4mm (16")
SPL at (1W/1m)	100dB	100dB
MAX. RATED SPL	125dB	126dB
NOMINAL IMPEDANCE	8Ω	8Ω
CROSSOVER FREQUENCY	4kHz	2kHz
PORT	Free Flow Flared	Free Flow Flared
INPUT CONNECTORS	1/4" Phone Jack + Terminal Strip	Speakon + Terminal Strip
DIMENSIONS	W550 x H755 x D425 mm	W530 x H840 x D415 mm
WEIGHT	33.00kg	37.60kg



SPX-450 400 WATTS

A high efficiency 400 Watts professional 2-Way PA Loudspeaker has superb low frequency response, long throw and excellent sound intelligibility. Two 30.48 cm (12") high performance LF loudspeakers and an high frequency compression horn driver housed in an acoustically treated bass reflex trapezoidal Carpet covered enclosure. Strong steel grille for speaker protection. Heavy duty metal handles provide ease of mobility and transportation. Ideal for Auditoria... Religious Gatherings... Live Concerts... DJs... etc.



SPX-610 500 WATTS

An elegant and sturdy 2-Way PA Loudspeaker in attractive painted enclosure. Continuous power handling capacity of 500W is achieved by using an efficient 38.1 cm (15") low frequency speaker and a reliable high frequency titanium compression horn driver. Acoustically treated bass reflex cabinet is designed for optimum low frequency reproduction with superb intelligibility of sound. Strong steel grille ensures speaker protection and durability. Heavy duty metal handles allow easy transportation. Ideal for use in a variety of indoor and outdoor PA applications.

SPECIFICATIONS	SPX-450	SPX-610
POWER RATING	400W RMS/800W Programme	500W RMS/1000W Programme
CONFIGURATION	Two Way	Two Way
FREQUENCY RESPONSE	45-20,000Hz	35-20,000Hz
LOW FREQUENCY SPEAKER	2 × 304.8mm (12") LF Speaker	1 × 381mm (15") LF Speaker
HIGH FREQUENCY UNIT	Dynamic Horn 101.6mm (4") × 254mm (10")	Dynamic Horn 177.8mm (7") × 406.4mm (16")
SPL at (1W/1m)	100dB	100dB
MAX. RATED SPL	124dB	127dB
NOMINAL IMPEDANCE	8Ω	8Ω
CROSSOVER FREQUENCY	4kHz	2kHz
PORT	Free Flow Flared	Free Flow Flared
INPUT CONNECTORS	Speakon + Terminal Strip	2 Nos. of Speakon Sockets
DIMENSIONS	W465 × H995 × D405 mm	W490 × H795 × D410mm
WEIGHT	38.80kg	38.40kg





2 × 15" 2 WAY

SPX-800
700 WATTS

This is 700 Watts Professional 2-Way PA Loudspeaker with excellent LF response, exceptional efficiency, long throw and unmatched intelligibility of sound. Two 38.1 cm (15") high performance LF loudspeakers and a high frequency Titanium compression horn driver housed in an acoustically treated bass reflex trapezoidal carpet covered enclosure. Strong steel grille for speaker protection. Heavy duty metal handles allow ease of mobility and transportation. Suitable for both indoor and outdoor sound reinforcement applications. Ideal for Auditoria... DJs... Live...Concerts... Discos... etc.



2 × 15" 2 WAY

SPX-810
700 WATTS

Professional 700 Watts 2-Way PA Loudspeaker in attractive painted enclosure. Loaded with two highly efficient 38.1 cm (15") low frequency speakers and a reliable high frequency titanium compression horn driver. Acoustically treated bass reflex cabinet is capable of producing excellent low frequency response together with impressive mid and high frequency response. Strong steel grille ensures speaker protection and durability. Heavy duty metal handles allow easy transportation. Ideal for use in a variety of indoor and outdoor sound reinforcement applications like Auditoria, DJs, Live Performances etc.

SPECIFICATIONS	SPX-800	SPX-810
POWER RATING	700W RMS/1400W Programme	700W RMS/1400W Programme
CONFIGURATION	Two Way	Two Way
FREQUENCY RESPONSE	40-20,000Hz	40-20,000Hz
LOW FREQUENCY SPEAKER	2 × 381 mm (15") LF Speaker	2 × 381 mm (15") LF Speaker
HIGH FREQUENCY UNIT	Dynamic Horn 177.8 mm (7") × 304.8 mm (16")	Dynamic Horn 177.8 mm (7") × 406.4 mm (16")
SPL at (1W/1m)	103dB	103dB
MAX. RATED SPL	131dB	131dB
NOMINAL IMPEDANCE	4Ω	4Ω
CROSSOVER FREQUENCY	2kHz	2kHz
PORT	Free Flow Flared	Free Flow Flared
INPUT CONNECTORS	2 Nos. of Speakon Sockets	2 Nos. of Speakon Sockets
DIMENSIONS	W542 × H1190 × D517 mm	W528 × H1188 × D496mm
WEIGHT	64.00kg	62.00kg



SPX-1200
1000 WATTS

Outstanding professional 2-Way PA Loudspeaker with 1000 Watts continuous power handling capacity. Two high power 38.1 cm (15") LF loudspeakers and a high frequency titanium compression horn driver give very well defined, prominent lows and brilliant highs. Acoustically treated bass reflex trapezoidal carpet covered cabinet with a strong steel grille ensures protection and durability. Heavy duty metal handles allow ease of mobility and transportation. Ideal for use with high powered amplifiers for large gatherings.



SPX-1210
1000 WATTS

Superb high power professional 2-Way PA Loudspeaker in attractive painted enclosure. Packed with two high power 38.1 cm (15") LF loudspeakers and a high frequency titanium compression horn driver give very well defined, prominent lows and brilliant highs. Acoustically treated bass reflex trapezoidal cabinet with a strong steel grille ensures protection and durability. Heavy duty metal handles allow ease of mobility and transportation. Ideal for use with high powered amplifiers for a variety of indoor and outdoor applications like Auditoria, DJs, Live Performances etc.

SPECIFICATIONS	SPX-1200	SPX-1210
POWER RATING	1000W RMS/2000W Programme	1000W RMS/2000W Programme
CONFIGURATION	Two Way	Two Way
FREQUENCY RESPONSE	35-20,000Hz	35-20,000Hz
LOW FREQUENCY SPEAKER	2 × 381 mm (15") LF Speaker	2 × 381 mm (15") LF Speaker
HIGH FREQUENCY UNIT	Dynamic Horn 177.8 mm (7") × 406.4 mm (16")	Dynamic Horn 177.8 mm (7") × 406.4 mm (16")
SPL at (1W/1m)	103dB	103dB
MAX. RATED SPL	133dB	133dB
NOMINAL IMPEDANCE	4Ω	4Ω
CROSSOVER FREQUENCY	2kHz	2kHz
PORT	Free Flow Flared	Free Flow Flared
INPUT CONNECTORS	Speakon + Terminal Strip	Speakon + Terminal Strip
DIMENSIONS	W550 × H1265 × D483 mm	W542 × H1253 × D475 mm
WEIGHT	67.80kg	69.80kg





SRM-120 100 WATTS

Compact 2-Way Stage Monitor Loudspeaker comprising of a single 30.48 cm (12") Full Range Dual Cone Speaker and a Piezo Horn Tweeter. An optimally angled enclosure for effective floor monitoring in various indoor & outdoor applications. The system is housed in an acoustically treated Bass Reflex enclosure made of 18mm board and carpet covered.



SRM-220 200 WATTS

Compact 2-Way Stage Monitor Loudspeaker comprising of a single 38.1 cm (15") Full Range Dual Cone Speaker and a Piezo Horn Tweeter. The unique multi functional trapezoidal design of the enclosure for effective floor monitoring in various indoor & outdoor applications. The system is housed in an acoustically treated Bass Reflex enclosure made of 18mm board and carpet covered. An On/Off switch for the piezo speaker is provided to limit extended HF, if desired. Stand mount adaptor is provided at the bottom.

SPECIFICATIONS	SRM-120	SRM-220
POWER RATING	100W RMS/200W Programme	200W RMS/400W Programme
CONFIGURATION	Two Way	Two Way
FREQUENCY RESPONSE	55-20,000Hz	50-20,000Hz
LOW FREQUENCY SPEAKER	1 × 304.8 mm (12"), Ø38.1 mm (1.5") Voice Coil	1 × 381 mm (15"), Ø50.8 mm (2.0") Voice Coil
HIGH FREQUENCY UNIT	1 × Piezo Horn Tweeter 50.8 mm (2") × 127 mm (5")	1 × Piezo Horn Tweeter 76.2 mm (3") × 152.4 mm (6")
SPL at (1W/1m)	97dB	98dB
MAX. RATED SPL	117dB	121dB
NOMINAL IMPEDANCE	8 Ω	8 Ω
PORT	Free Flow Flared	Free Flow Flared
INPUT CONNECTORS	1/4" Phone Jack + Terminal Strip	1/4" Phone Jack + Terminal Strip
DIMENSIONS	W425 × H560 × D358 mm	W520 × H690 × D420 mm
WEIGHT	16.20kg	25.00kg

SMS-450 400 WATTS



Elegant & compact 2-Way Stage Monitor Loudspeaker comprising of a single 38.1 cm (15") LF Speaker and 2.54 cm (1") throat HF Compression Horn Driver. An optimally angled enclosure for effective floor monitoring in various indoor & outdoor applications. The system is housed in an acoustically treated Bass Reflex enclosure made of 18mm board in durable paint finish. Adaptor is provided at the bottom for stand mount applications. Heavy duty metal handles allow ease of mobility and transportation.

SPECIFICATIONS	SMS-450
POWER RATING	400W RMS/800W Programme
CONFIGURATION	Two Way
FREQUENCY RESPONSE	45-18,000Hz
LOW FREQUENCY SPEAKER	1 × 381 mm (15"), Ø76.2 mm (3") Voice Coil
HIGH FREQUENCY UNIT	1 × Dynamic Horn 177.8 mm (7") × 406.4mm (16")
SPL at (1W/1m)	98dB
MAX. RATED SPL	124dB
NOMINAL IMPEDANCE	8Ω
PORT	Free Flow Flared
INPUT CONNECTORS	2 Nos. of Speakon Socket
DIMENSIONS	W700 × H400 × D525mm
WEIGHT	29.8 kg



PA Active Loudspeaker - Stage Monitor

SMS-450P 400 WATTS



Rear View



Professional 2-Way Active Stage Monitor Loudspeaker has built-in Bi-Amplifier for LF and HF driver separately. An optimally angled enclosure for effective floor monitoring in various indoor & outdoor applications. The system is housed in an acoustically treated Bass Reflex enclosure made of 18mm board in durable paint finish. Adaptor is provided at the bottom for stand mount applications. Heavy duty metal handles allow ease of mobility and transportation.

- 1 x Balanced Mic/Line Input selectable through a push switch.
- 1 x Line Input can be used for connecting balanced MONO signal through jack or unbalanced STEREO signal source through dual RCA.
- Balanced output to link another SMS-450P or for recording on a computer, record player.
- Switchable balanced output either as a Loop through output of Input-1 or a mix output of Input-1 and 2.
- 2-Way Speaker System: 38.1 cm (15") LF Woofer (\varnothing 76.2 cm (3.0") voice coil) + Dynamic Horn (\varnothing 4.44 cm 1.75" voice coil).

SPECIFICATIONS	SMS-450P
POWER OUTPUT (Bi-AMP)	LF: 350W RMS at 1% THD Class H, HF: 50W RMS at 1% THD Class AB
OUTPUT REGULATION	Better than 0.5dB
INPUT CHANNELS	INPUT-1: MIC 20mV/3k Ω balanced, LINE: 775mV/10k Ω balanced, INPUT-2: LINE (Jack) 250mV/20k Ω balanced, RCA: 250mV (L&R)/10k Ω
FREQUENCY RESPONSE	50-20,000Hz \pm 3DB
CROSSOVER FREQUENCY	2.5kHz, Filter Slope 24dB per octave
SIGNAL TO NOISE RATIO	60dB
TONE CONTROLS	Bass: \pm 5dB at 100Hz, Treble: \pm 5dB at 10kHz
OUTPUT	(a) Loop through (INPUT-1): 20mV or 775mV, (b) Mixed Output (1+2): 775mV/1k Ω
PROTECTIONS	AC: Fuse 1x5A (T 5A L) DC: Fuse 2x8A (T 8A L)
POWER SUPPLY	AC: 220-240V 50/60Hz
AC POWER CONSUMPTION	500VA
DIMENSIONS	W700 \times H400 \times D525mm
WEIGHT	35.50kg



VX-200
200 WATTS



Compact & portable 200W, 2-Way PA Loudspeaker comprises of a high performance 25.4 cm (10") 200W LF speaker and a reliable HF driver. Ideal for use in a wide variety of speech & music applications.

- Rugged & portable bass reflex cabinet moulded with a special polypropylene plastic material. Equipped with a professional passive crossover network using low resistance inductors & high quality metallised polyester capacitors.
- Special cabinet profile allows functional flexibility in various professional audio applications such as stage monitors, live sound reinforcement and installed sound systems. A pole socket is provided at the bottom for easy stand mounting as well as wall mounting.
- Three integrated M8 flying points on top side and right side of the cabinet enable vertical and horizontal suspension applications.



VX-300
300 WATTS



Compact & exquisite 300W, 2-Way PA Loudspeaker comprises of a high performance 30.4 cm (12") 300W LF speaker and a reliable HF driver. Ideal for use in a wide variety of speech & music applications.

- Rugged & portable bass reflex cabinet moulded with a special polypropylene plastic material. Equipped with a professional passive crossover network using low resistance inductors & high quality metallised polyester capacitors.
- Special cabinet profile allows functional flexibility in various professional audio applications such as stage monitors, live sound reinforcement and installed sound systems. A pole socket is provided at the bottom for easy stand mounting as well as wall mounting.
- Three integrated M8 flying points on top side and right side of the cabinet enable vertical and horizontal suspension applications.



VX-400
400 WATTS



High quality 400W, 2-Way PA speaker Loudspeaker comprises of a high performance 38.1 cm (15") 400W LF speaker and a reliable HF driver. Ideal for use in a wide variety of speech & music applications.

- Rugged & portable bass reflex cabinet moulded with a special polypropylene plastic material. Equipped with a professional passive crossover network using low resistance inductors & high quality metallised polyester capacitors.
- Special cabinet profile allows functional flexibility in various professional audio applications such as stage monitors, live sound reinforcement and installed sound systems. A pole socket is provided at the bottom for easy stand mounting as well as wall mounting.
- Three integrated M8 flying points on top side and right side of the cabinet enable vertical and horizontal suspension applications.

SPECIFICATIONS	VX-200	VX-300	VX-400
POWER RATING	200W RMS/400W Programme	300W RMS/600W Programme	400W RMS/800W Programme
CONFIGURATION	Two Way	Two Way	Two Way
FREQUENCY RESPONSE	65-18,000Hz	60-18,000Hz	45-18,000Hz
LOW FREQUENCY SPEAKER	1 x 254 mm (10"), Ø50.8 mm (2.0") CCAW Voice Coil	1 x 304.8 mm (12"), Ø63.5 mm (2.5") CCAW Voice Coil	1 x 381 mm (15"), Ø76.2 mm (3.0") CCAW Voice Coil
HIGH FREQUENCY UNIT	Dynamic Horn, Ø25.4 mm (1") Voice Coil	Dynamic Horn, Ø44.45 mm (1.75") Voice Coil	Dynamic Horn, Ø44.45 mm (1.75") Voice Coil
SPL at (1W/1m)	94dB	97dB	98dB
MAX. RATED SPL	117dB	122dB	124dB
NOMINAL IMPEDANCE	8Ω	8Ω	8Ω
PORT	Free Flow Flared	Free Flow Flared	Free Flow Flared
INPUT CONNECTORS	1/4" Phone Jack + Push Terminals	Speakon + Push Terminals	2 Nos. of Speakon Sockets
DIMENSIONS	W325 × H485 × D255 mm	W385 × H585 × D305 mm	W460 × H690 × D370 mm
WEIGHT	9.70kg	16.00kg	22.10kg



PA Active Loudspeaker - Subwoofer

SUB-300A 300 WATTS



Rear View



Compact and elegant 300W powered subwoofer loudspeaker for use in a variety of indoor and open air applications. It comprises of an efficient 30.48 cm (12") subwoofer and a matching built-in amplifier for delivering powerful deeper bass response. The system is housed in a rugged bass reflex enclosure with excellent texture paint finish. The rear plate has various features like BYPASS switch for high pass filter, PHASE reversal switch and GROUND lift switch which are easily selectable through push switches. It also provides ease of interconnections through a variety of XLR and COMBO connectors. A stand adaptor has been provided at the top of the cabinet for pole mounting a full range speaker system. Strong grille is designed to provide necessary protection to the speaker as well as professional appearance to the product. Built-in handles for smooth handling and easy portability of the product.

SPECIFICATIONS	SUB-300A
POWER OUTPUT	300W RMS
INPUT	1V / 0dBu
FREQUENCY RESPONSE (-6dB)	47-125 Hz
SPL at (1W/1m)	96dB
MAX. RATED SPL	121dB
LOW FREQUENCY SPEAKER	1 × 304.8 mm (12") with Ø63.5 mm (2.5") Voice Coil
INPUT CONNECTORS	LEFT/MONO: COMBO (XLR+ 1/4" Stereo Jack), RIGHT: F/XLR, LINK L&R: 2 × M/XLR
OUTPUT CONNECTORS	LEFT/MONO & RIGHT: 2 × M/XLR
PROTECTION	AC: Fuse 1 × 3A (T 3A L)
POWER SUPPLY	AC: 220-240V 50/60Hz
AC POWER CONSUMPTION	400 VA
DIMENSIONS	W530 × H370 × D480 mm
WEIGHT	18.60kg



SWX-650 650 WATTS

The SWX-650 is a professional high power SUBWOOFER employing an extremely efficient 45.72 cm (18") LF driver with an extended low frequency response. It is the perfect solution to any need where significant extension of the low frequency output is required. The system is housed in a Rugged Bass Reflex Enclosure made of 18mm board. The cabinet has been reinforced with bracing and is Carpet covered which keeps the first day appearance longer. A stand adapter has been provided at the top of the cabinet for pole mounting a full range speaker. The cabinet is fitted with heavy duty handles for ease of transportation. The strong metal grille protects the speaker from unavoidable strokes.



SWX-810 800 WATTS

SWX-810 is a high power professional passive SUBWOOFER driven by one efficient 45.72 cm (18") LF driver. Housed in a specially designed bass reflex enclosure to provide superior bass response with higher power handling capacity. Strong and durable wooden enclosure is well braced internally and attractively paint finished externally. Protective grille has robust design to provide required protection to the speaker and professional appearance to the product. The enclosure is fitted with four heavy duty handles, a recessed terminal plate and four indexed feet for ease of stacking. Speakon connector and Terminal Strip are provided for quick and convenient connections.



SWX-1000 1000 WATTS

The SWX-1000 is a high reliability super power SUBWOOFER with exceptional distortion-free low frequency response. It is fitted with a 45.72 cm (18") LF driver having 12.7 cm (5") inside/outside voice coil wound on a polyimide fibre glass former. The speaker has an aluminium demodulating ring for better heat dissipation and a specially treated cone for water splash resistance. The cabinet is rugged and specially braced to withstand intense vibrations. Wide port design for increased efficiency. A stand adapter has been provided at the top of the cabinet for pole mounting a full range speaker. The cabinet is fitted with heavy duty handles for ease of transportation. The strong metal grille protects the speaker from unavoidable strokes.

SPECIFICATIONS	SWX-650	SWX-810	SWX-1000
POWER RATING	650W RMS/1300W Programme	800W RMS/1600W Programme	1000W RMS/2000W Programme
CONFIGURATION	One Way	One Way	One Way
FREQUENCY RESPONSE	30-250Hz	38-200Hz	36-200Hz
LOW FREQUENCY SPEAKER	1 x 457.2 mm (18") with Ø101.6 mm (4") Edge Wound Voice Coil	1 x 457.2 mm (18") with Ø101.6 mm (4") Inside/Outside Copper Voice Coil	1 x 457.2 mm (18") with Ø127 mm 5" Inside/Outside Wound Voice Coil
SPL at (1W/1m)	99dB	98dB	99dB
MAX. RATED SPL	127dB	127dB	129dB
NOMINAL IMPEDANCE	8Ω	8Ω	8Ω
PORT	Free Flow Flared	Free Flow Flared	Free Flow Flared
INPUT CONNECTORS	Terminal Strip + Speakon	Terminal Strip + Speakon	Terminal Strip + Speakon
DIMENSIONS	W575 × H780 × D500 mm	W538 × H710 × D700 mm	W610 × H845 × D540 mm
WEIGHT	47.20kg	55.00kg	53.00kg



PA Cabinet Loudspeakers - Subwoofer

SWX-1300DX 1300 WATTS



Rugged cabinet loudspeaker with two extremely efficient 45.72 cm (18") LF drivers for higher power handling capacity, deeper bass, and smoother spatial distribution of the extended bass. Very strong carpet covered cabinet with 25mm thick wooden baffle and extensive internal bracing to prevent unwanted vibrations and rattling. Provided with an attractive & modern extra-thick grille, and four steel handles for easy handling. Bass reflex design tuned with a large, wide angle port. An ideal cabinet speaker for use with high power amplifiers for reinforcement of the extended low frequency spectrum.

SPECIFICATIONS	SWX-1300DX
POWER RATING	1300W RMS/2600W Programme
CONFIGURATION	One Way
FREQUENCY RESPONSE	30-250Hz
LOW FREQUENCY SPEAKER	2 x 457.2 mm (18") with \varnothing 101.6 mm (4") Edge Wound Voice Coil
SPL at (1W/1m)	102dB
MAX. RATED SPL	133dB
NOMINAL IMPEDANCE	4 Ω
PORT	Free Flow Flared
INPUT CONNECTORS	2 Nos. of Speakon Sockets
DIMENSIONS	W1075 \times H660 \times D610 mm
WEIGHT	83.00kg

SWX-2100 2000 WATTS



Compact and powerful 2000W professional subwoofer driven by two efficient 45.72 cm (18") LF driver to provide excellent bass and super power handling capacity. Built into a strong and durable thick wooden enclosure which is well braced internally and attractively paint finished externally. This bass reflex enclosure design, with minimum footprint, suits all types of installed and touring applications. Strong extra -thick grille is designed to give required protection to the speakers and professional appearance to the product. The enclosure is fitted with four heavy duty handles for easy handling. Six indexed feet on top surface provide easy and secure stacking of subwoofer cabinets. Two speakon connectors on the rear terminal plate are provided for quick & convenient connections.

SPECIFICATIONS	SWX-2100
POWER RATING	2000W RMS/4000W Programme
CONFIGURATION	One Way
FREQUENCY RESPONSE	36-200Hz
LOW FREQUENCY SPEAKER	2 x 457.2 mm (18") with Ø127 mm (5") Inside/Outside Wound Voice Coil
SPL at (1W/1m)	102dB
MAX. RATED SPL	135dB
NOMINAL IMPEDANCE	4Ω
PORT	Free Flow Flared
INPUT CONNECTORS	2 × Speakon
DIMENSIONS	W1000 × H675 × D706 mm
WEIGHT	99.00kg



PA Cabinet Loudspeakers - Subwoofer

SWX-2600 2600 WATTS



Rugged and powerful 2600W professional subwoofer driven by two efficient 45.72 cm (18") LF drivers to generate superb bass response and provide super power handling capacity. Built into a strong and durable thick wooden enclosure which is well braced internally and attractively paint finished externally. This bass reflex enclosure design suits all types of installed and touring applications. Strong extra -thick grille is designed to give required protection to the speakers and professional appearance to the product. The enclosure is fitted with four heavy duty handles for easy handling. Six indexed feet on top surface provide easy and secure stacking of subwoofer cabinets. Two speakon connectors on the rear terminal plate are provided for quick & convenient connections.

SPECIFICATIONS	SWX-2600
POWER RATING	2600W RMS/5200W Programme
CONFIGURATION	One Way
FREQUENCY RESPONSE	35-200Hz
LOW FREQUENCY SPEAKER	2 x 457.2 mm (18") with \varnothing 127 mm (5") Inside / Outside Wound Voice Coil
SPL at (1W/1m)	102dB
MAX. RATED SPL	135dB
NOMINAL IMPEDANCE	4 Ω
PORT	Free Flow Flared
INPUT CONNECTORS	2 \times Speakon
DIMENSIONS	W1100 \times H625 \times D790 mm
WEIGHT	105.00kg

ALA-2400 200 WATTS



A full bandwidth modular line array comprising 4 trapezoidal enclosures arrayed in a vertical pattern for controlled directivity. The four enclosures are intended to be used as an integrated unit, and are packaged as a single variable dispersion system with nominal impedance 8 ohms.

The line array package is aesthetically elegant and handsome, and also delivers exceptionally good, clear, intelligible sound – directed wherever it is most required. The line array is supplied fitted with a wall mount bracket and handle. The relative angle between each of the enclosures is adjustable from 15 degrees to 60 degrees in 15 degree increments.

Ideal for use in [Auditoria](#)... [Gymnasiums](#)... [Sports Arenas](#)... [Indoor Stadia](#)... [Malls](#)... [Reception Halls](#)...

SPECIFICATIONS	ALA-2400
INPUT POWER	200W RMS
FREQUENCY RESPONSE	70-20,000Hz (60° mode), 75-20,000Hz (45° mode), 80-20,000Hz (30° mode), 85-20,000Hz (15° mode)
SPEAKER	Woofer 4 × 127mm (5"), Tweeter 12 × 25.4mm (1") Dome Tweeter
SPL at 1kHz (1W/1m)	96dB (60° mode), 97dB (45° mode), 98dB (30° mode), 99dB (15° mode)
NOMINAL IMPEDANCE	8Ω
CROSSOVER FREQUENCY	4kHz
INPUT CONNECTORS	Speakon + Terminal Strip
DIMENSIONS	W408 × H546 × D342 mm
WEIGHT	16.00kg



PA Line Array Loudspeakers

ALX-6000 500 WATTS

1x12"

8Ω



ALX-6000 is a compact single 30.48 cm (12") Line Array Loudspeaker. Each module of ALX-6000 comprises of a powerful LF driver and a high performance HF driver to deliver crisp, clear and clean sound in a variety of indoor and outdoor installations.

- Each line array cabinet is designed to provide controlled & coherent coverage pattern with excellent high frequency response.
- Comprises of a powerful HF driver with a waveguide horn for constant curvature line array system.
- Simple rigging arrangement for quick & secure installation.
- Professional 2-way passive crossover network with HF protection.
- Switch provided on terminal plate for selecting HF long throw (0dB) and short throw (-3dB).
- Strong, well braced & resonance free speaker cabinet in durable paint finish.
- Heavy duty steel grille with acoustically transparent foam to protect speakers from various adverse working conditions.
- A sturdy and rugged flybar frame is available for rigging the line array cabinets.
- Suitable for a wide variety of applications in Fixed Installations, Rental, Djs and Live Sound Reinforcement.

SPECIFICATIONS	ALX-6000
POWER RATING	500W RMS
CONFIGURATION	Two Way
FREQUENCY RESPONSE	55-20,000Hz
LOW FREQUENCY SPEAKER	1 × 304.8 mm (12") Woofer
HIGH FREQUENCY UNIT	1 x 38.1mm (1.5") Throat Compression Driver
SPL (1W/1m)	96dB
MAX RATED SPL	122dB
NOMINAL IMPEDANCE	8Ω
HORIZONTAL COVERAGE ANGLE	120°
VERTICAL COVERAGE ANGLE	10°
VARIABLE SPLAY ANGLES	0°, 1°, 2°, 3°, 4°, 5°, 6°, 7°, 8°
CONNECTORS	2 Nos. of Speakon Sockets
DIMENSIONS	W675 x H355 x D530 mm
WEIGHT	48.50kg

ALX-11000 1000 WATTS



ALX-11000 is a high performance dual 30.48 cm 12" Line Array Loudspeaker. Each module of ALX-11000 comprises of two powerful LF drivers and a high quality HF driver to deliver natural, intelligible and clear sound in a variety of music & speech applications.

- Each line array cabinet is designed to provide controlled & coherent coverage pattern with excellent high frequency response.
- Comprises of a powerful HF driver with a waveguide horn for constant curvature line array system.
- Simple rigging arrangement for quick & secure installation.
- Professional 2-way passive crossover network with HF protection.
- Strong, well braced & resonance free speaker cabinet in durable paint finish.
- Heavy duty steel grille with acoustically transparent foam to protect speakers from various adverse working conditions.
- A sturdy and rugged flybar frame is available for rigging the line array cabinets.
- Suitable for a wide variety of applications in Fixed Installations, Rental, Djs and Live Sound Reinforcement.

SPECIFICATIONS	ALX-11000
POWER RATING	1000W RMS
CONFIGURATION	Two Way
FREQUENCY RESPONSE	55-20,000Hz
LOW FREQUENCY SPEAKER	2 × 304.8 mm (12") Woofer
HIGH FREQUENCY UNIT	1 × 38.1 mm (1.5") Throat Compression Driver
SPL (1W/1m)	98dB
MAX RATED SPL	128dB
NOMINAL IMPEDANCE	8Ω
HORIZONTAL COVERAGE ANGLE	120°
VERTICAL COVERAGE ANGLE	10°
VARIABLE SPLAY ANGLES	0°, 1°, 2°, 3°, 4°, 5°, 6°, 7°, 8°
CONNECTORS	2 Nos. of Speakon Sockets
DIMENSIONS	W1030 x H355 x D530 mm
WEIGHT	74.00kg



High quality 12" mid-bass speaker



AS12-X100® 100 WATTS

- Sturdy pressed metal frame in elegant brown colour.
- Kapton former voice coil for withstanding high temperature.
- Suitable for use in compact 2-way sealed as well as bass reflex enclosures.
- Excellent low frequency response makes it ideal for Dandiya-Ras, DJs & General PA applications.

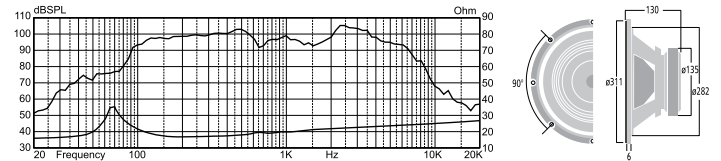

High quality 15" mid-bass speaker



AS15-X200® 200 WATTS

- Sturdy pressed metal frame in elegant brown colour.
- Special high temperature voice coil for exceptional thermal capabilities.
- Suitable for use in compact 2-way sealed as well as bass reflex enclosures.
- Excellent low frequency response makes it ideal for Dandiya-Ras, DJs & General PA applications.

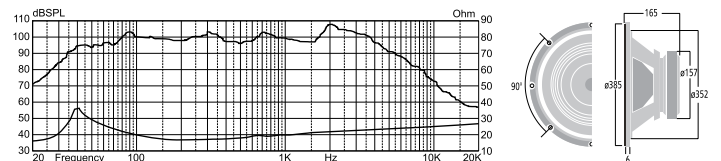

SPECIFICATIONS	AS12-X100®	AS15-X200®
POWER RATING	100W RMS/200W Programme	200W RMS/400W Programme
NOMINAL DIAMETER	305 mm (12")	380 mm (15")
NOMINAL IMPEDANCE	8Ω	8Ω
SENSITIVITY (1W/1m)	97dB	98dB
MAGNET WEIGHT	1.1kg	1.54kg
RESONANT FREQUENCY (Fs)	70Hz	45Hz
DC RESISTANCE (Re)	6.0Ω	6.0Ω
ELECTROMAGNETIC Q (Qes)	0.79	0.58
MECHANICAL Q (Qms)	5.5	9.6
TOTAL Q (Qts)	0.69	0.54
COMPLIANCE EQUIVALENT VOLUME (VAS)	74.23 Litr	115 Litr
SURFACE AREA OF CONE (Sd)	510cm ²	830cm ²
REFERENCE EFFICIENCY (η ₀)	3.09%	2.1%
VOICE COIL	1.5"	2.0"
OVERHANG (X _{max})	2.0mm	3.5 mm
MOVING MASS (M _{ms})	25.5gm	73gm
BL PRODUCT (BL)	9.2TM	13.4TM
OVERALL DIAMETER	311 mm	385 mm
DEPTH	130 mm	165 mm
BAFFLE HOLE DIAMETER	285 mm	355 mm
BOLT MOUNT DIAMETER (PCD)	292 mm (8 Bolts)	373 mm (8 Bolts)
WEIGHT	3.20kg	4.90kg

High efficiency 12" dual cone full range speaker **SK-12FR[®]X/SK-12FR[®]Z** 100 WATTS



- They are 30.48cm (12") dual cone full range PA speakers with a very wide frequency range 55-16,000Hz.
- Impedance of SK-12FRX is 8Ω and SK-12FRZ is 16Ω.
- High quality specially designed imported parts for low distortion and a clean transparent sound.

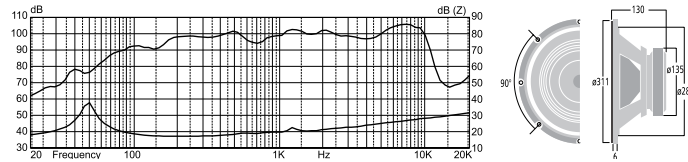

High efficiency 12" dual cone full range speaker **DX12-F200[®]/DZ12-F200[®]** 200 WATTS



- 30.48cm (12") dual cone speaker with wide spectrum frequency response.
- High quality specially designed imported cones and spider for extremely clear, low distortion sound reproduction.
- Impedance of DX12-F200 is 8Ω and DZ12-F200 is 16Ω.
- 5.08 cm (2") CCAW voice coil with high temperature rating for safe, reliable operation.

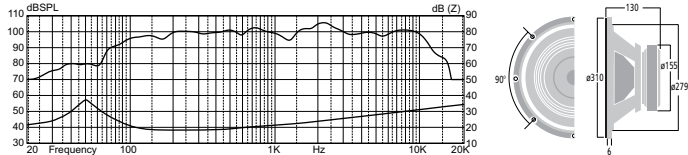

High efficiency 15" dual cone full range speaker **SK-15FR[®]X/SK-15FR[®]Z** 200 WATTS



- It is a 38.1 cm (15") high quality dual cone full range PA speaker with a very wide frequency range 50-16,000Hz.
- Impedance of SK-15FRX is 8Ω and SK-15FRZ is 16Ω.
- High quality specially designed imported parts for low distortion & clean sound.

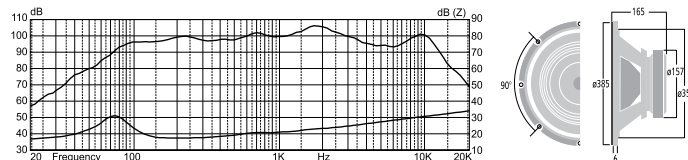

SPECIFICATIONS	SK-12FR [®] X/SK-12FR [®] Z	DX12-F200 [®] /DZ12-F200 [®]	SK-15FR [®] X/SK-15FR [®] Z
POWER RATING	100W RMS/200W Programme	200W RMS/400W Programme	200W RMS/400W Programme
NOMINAL DIAMETER	305mm (12")	305 mm (12")	380mm (15")
NOMINAL IMPEDANCE	8 Ω /16 Ω	8 Ω /16 Ω	8 Ω /16 Ω
SENSITIVITY (1W/1m)	97dB	97dB	98 dB
MAGNET WEIGHT	1.1kg	1.16kg	1.54kg
RESONANT FREQUENCY (Fs)	50Hz	50Hz	75Hz
DC RESISTANCE (Re)	6.4 Ω /13.0 Ω	6.8 Ω /13.0 Ω	6.5 Ω /11.0 Ω
ELECTROMAGNETIC Q (Qes)	0.758	0.92	0.91
MECHANICAL Q (Qms)	9.36	3.26	5.07
TOTAL Q (Qts)	0.7	0.72	0.77
COMPLIANCE EQUIVALENT VOLUME (VAS)	104 Litr	—	75.11Litr
SURFACE AREA OF CONE (Sd)	510cm ²	510cm ²	830cm ²
REFERENCE EFFICIENCY (ηo)	1.7%	3.6%	3.18%
VOICE COIL DIAMETER	1.5"	2.0"	2.0"
OVERHANG (Xmax)	1.5 mm	2.5 mm	4.0 mm
MOVING MASS (Mms)	35.23gm	36.7gm	60.62gm
BL PRODUCT (BL)	9.7TM	11.2TM	14.23TM
COIL INDUCTANCE (Le)	0.79mH	0.69mH	0.78mH
OVERALL DIAMETER	311 mm	313 mm	385 mm
DEPTH	130 mm	127 mm	165 mm
BAFFLE HOLE DIAMETER	285 mm	285 mm	355 mm
BOLT MOUNT DIAMETER (PCD)	292 mm (8 Bolts)	295 mm (8 Bolts)	373 mm (8 Bolts)
WEIGHT	3.20kg	4.16kg	4.90kg



PA Speakers

Medium power 12" low frequency speaker



L12-MB200® 200 WATTS

- Specially designed for use in medium power compact 2-Way speaker systems. Suitable for bass-midrange and monitoring applications.
- Robust steel frame and plasticized cloth edge composite cone.
- KAPTON former 5.08 cm (2.0") copper voice coil for withstanding high temperatures.

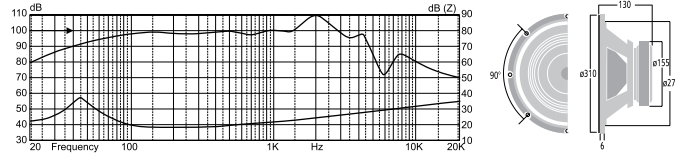

High power 12" low frequency speaker



L12-MB300 300 WATTS

- Exclusively designed for use in high power compact 2-Way speaker systems. Ideal for bass & midrange application in bass reflex cabinets.
- Strong die-cast aluminium frame for reliable performance.
- 7.62 cm (3") Copper Clad Aluminium Wire voice coil wound on GLASS FIBRE former. Gold plated push type heavy duty terminals for firm connection.

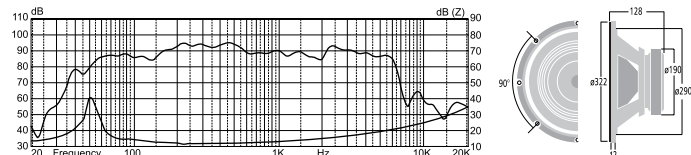

High power 15" low frequency speaker



L15-MB300® 300 WATTS

- Excellent low and mid frequency response, Ideal for bass and bass-midrange applications in bass reflex cabinets.
- Aluminium die-cast frame with vented-gap cooling technique.
- 7.62 cm (3") Copper Clad Aluminium Wire voice coil wound on GLASS FIBRE former.
- Gold plated push type heavy duty terminals for firm connection.

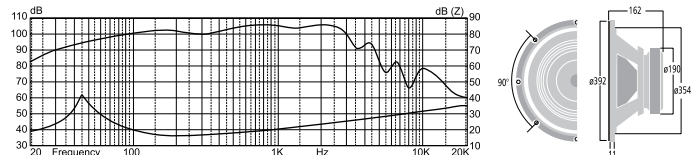

SPECIFICATIONS	L12-MB200®	L12-MB300	L15-MB300®
POWER RATING	200W RMS/400W Programme	300W RMS/600W Programme	300W RMS/600W Programme
NOMINAL DIAMETER	305mm (12")	305mm (12")	380mm (15")
NOMINAL IMPEDANCE	8Ω	8Ω	8Ω
SENSITIVITY (1W/1m)	97dB	99dB	99dB
MAGNET WEIGHT	1.16 Kg	2.31kg	2.31kg
RESONANT FREQUENCY (Fs)	45Hz	48Hz	45Hz
DC RESISTANCE (Re)	7Ω	5.4Ω	5.7Ω
ELECTROMAGNETIC Q (Qes)	0.46	0.33	0.32
MECHANICAL Q (Qms)	4.67	4.94	5.82
TOTAL Q (Qts)	0.42	0.30	0.3
COMPLIANCE EQUIVALENT VOLUME (VAS)	135Litr	71Litr	139.65Litr
SURFACE AREA OF CONE (Sd)	510cm ²	531cm ²	830cm ²
REFERENCE EFFICIENCY (ηo)	1.35%	2.83%	4.35%
VOICE COIL	2.0"	3.0"	3.0"
MOVING MASS (Mms)	51.9gm	54.55gm	80.31gm
BL PRODUCT (BL)	13.42TM	17.11TM	20.49TM
COIL INDUCTANCE (Le)	0.89mH	0.85mH	0.68mH
OVERALL DIAMETER	313 mm	322 mm	395 mm
DEPTH	127 mm	128 mm	160 mm
BAFFLE HOLE DIAMETER	285 mm	290 mm	358 mm
BOLT MOUNT DIAMETER (PCD)	295 mm (8 Bolts)	305 mm (8 Bolts)	373 mm (8 Bolts)
WEIGHT	4.16kg	7.30kg	8.15kg

High power 15" low frequency speaker



L15-MB400® 400 WATTS

- Excellent low and mid frequency response.
- Ideal for high power 2-Way Speaker Systems.
- Triple roll, exponential cone geometry.
- High temperature copper clad aluminium wire voice coil wound on polyamide former.

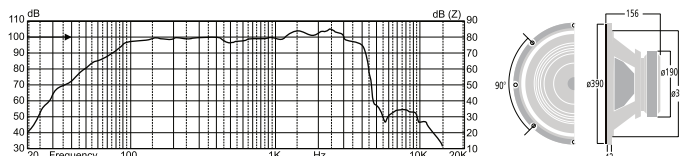

High power 15" low frequency speaker



L15-MB500® 500 WATTS

- Extended low frequency, ideal for Cinema Halls and for use in professional high power full range speaker systems.
- Aluminium die-cast frame with gold plated push type heavy duty terminals.
- GLASS FIBRE former for withstanding high temperature.
- 10.16 cm (4") Edge-wound copper wire voice coil for higher SPL.

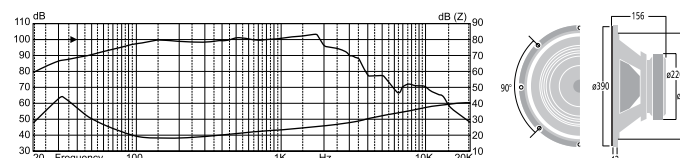

High power 15" low frequency speaker



L15-MB650® 650 WATTS

- Excellent bass and mid-bass response, high power handling capacity.
- Aluminium die-cast frame with gold plated push type heavy duty terminals.
- GLASS FIBRE former for withstanding high temperature.
- 10.16 cm (4") Edge-wound aluminium wire voice coil for higher SPL.

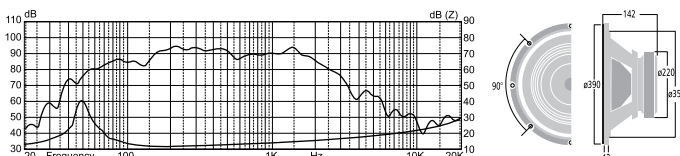

SPECIFICATIONS	L15-MB400®	L15-MB500®	L15-MB650®
POWER RATING	400W RMS/800W Programme	500W RMS/1000W Programme	650W RMS/1300W Programme
NOMINAL DIAMETER	380mm (15")	380mm (15")	380mm (15")
NOMINAL IMPEDANCE	8Ω	8Ω	8Ω
SENSITIVITY (1W/1m)	99dB	97dB	97dB
MAGNET WEIGHT	2.31kg	2.85kg	2.85kg
RESONANT FREQUENCY (Fs)	40Hz	33Hz	50Hz
DC RESISTANCE (Re)	5.8Ω	5 Ω	5.1Ω
ELECTROMAGNETIC Q (Qes)	0.41	0.34	0.32
MECHANICAL Q (Qms)	8.0	4.32	5.91
TOTAL Q (Qts)	0.39	0.32	0.30
COMPLIANCE EQUIVALENT VOLUME (VAS)	168Litr	221Litr	109Litr
SURFACE AREA OF CONE (Sd)	855cm ²	830cm ²	830cm ²
REFERENCE EFFICIENCY (ηo)	2.72%	2.28%	3.5%
VOICE COIL	3.0"	4.0"	4.0"
MOVING MASS (Mms)	91gm	107.17gm	97.60gm
BL PRODUCT (BL)	18TM	18TM	22.92TM
COIL INDUCTANCE (Le)	1.1mH	1.09mH	1.60mH
OVERALL DIAMETER	389.5 mm	387 mm	390 mm
DEPTH	157 mm	158 mm	142 mm
BAFFLE HOLE DIAMETER	350 mm	354 mm	357 mm
BOLT MOUNT DIAMETER (PCD)	369 mm (8 Bolts)	369 mm (8 Bolts)	372 mm (8 Bolts)
WEIGHT	7.80kg	9.00kg	11.00kg



High power 18" extended low frequency speaker



L18-SW650® 650 WATTS

- Extremely great linear excursion, ideal for powerful bass and subwoofer applications.
- Aluminium die-cast frame and robust construction.
- Tear resistant tetron-cotton blend rolled cloth edge.
- Cotton polyester blend spider.
- GLASS FIBRE former voice coil for withstanding high temperature.
- 10.16 cm (4") Edge-wound aluminium wire voice coil for higher SPL.
- Ideal professional bass speaker for all PA, sound reinforcement and live music application.

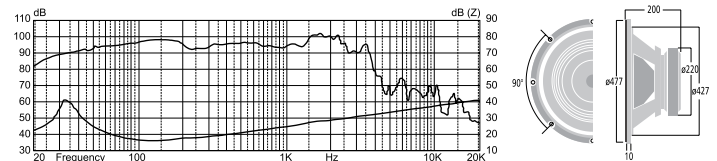

High power 18" extended low frequency speaker



L18-SW800 800 WATTS

- Powerful and reliable speaker for various bass & subwoofer applications.
- Robust aluminium die-cast frame with dual forced air ventilation for efficient heat dissipation.
- GLASS FIBRE former voice coil for withstanding high temperatures.
- 10.16 cm (4") INSIDE/OUTSIDE copper voice coil.
- Triple roll surround and re-inforced conex spider for improved linearity control.
- Ideal professional bass speaker for live music, sound reinforcement and all PA applications.

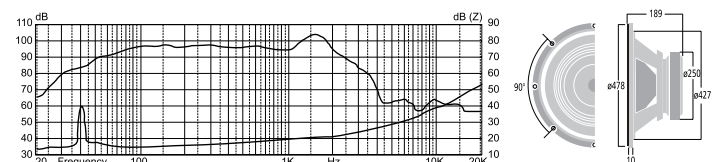

SPECIFICATIONS	L18-SW650®	L18-SW800
POWER RATING	650W RMS/1300W Programme	800W RMS/1600W Programme
NOMINAL DIAMETER	457mm (18")	457mm (18")
NOMINAL IMPEDANCE	8Ω	8Ω
SENSITIVITY (1W/1m)	98dB	98dB
MAGNET WEIGHT	3.56kg	4.60kg
RESONANT FREQUENCY (Fs)	32Hz	41Hz
DC RESISTANCE (Re)	5.1 Ω	5.4Ω
ELECTROMAGNETIC Q (Qes)	0.26	0.38
MECHANICAL Q (Qms)	5.29	11.10
TOTAL Q (Qts)	0.245	0.37
COMPLIANCE EQUIVALENT VOLUME (VAS)	246 Litr	176 Litr
SURFACE AREA OF CONE (Sd)	1225cm ²	1225cm ²
REFERENCE EFFICIENCY (ηo)	3.12%	2.8%
VOICE COIL	4.0"	4.0"
OVERHANG (Xmax)	5.0 mm	8.0 mm
MOVING MASS (Mms)	218gm	185gm
BL PRODUCT (BL)	29.64TM	25.3TM
COIL INDUCTANCE (Le)	1.9mH	2.1mH
OVERALL DIAMETER	476 mm	478 mm
DEPTH	205 mm	189 mm
BAFFLE HOLE DIAMETER	424 mm	427 mm
BOLT MOUNT DIAMETER (PCD)	450 mm (8 Bolts)	451 mm (8 Bolts)
WEIGHT	13.30kg	16.10kg

Super power 18" extended low frequency speaker



L18-SW1000® 1000 WATTS

- Super power and reliable speaker for powerful bass & subwoofer applications.
- Robust aluminium die-cast frame with efficient heat dissipating vents. Aluminium demodulating ring for enhanced heat dissipation.
- DOUBLE SPIDER design for better excursion control. GLASS FIBRE former voice coil for withstanding high temperatures.
- 12.7 cm (5") INSIDE/OUTSIDE CCAW voice coil for higher SPL.
- Cone specially treated for water splash resistance.
- Ideal professional bass speaker for live music, sound reinforcement and all PA applications.

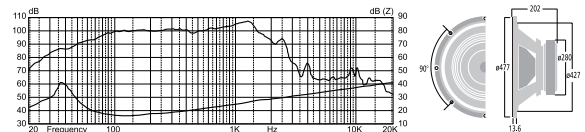

Super power 18" extended low frequency speaker



L18-SW1300V/ L18-SW1300X 1300 WATTS

- Delivers deep, powerful bass in compact bass reflex as well as horn loaded sub-woofer design.
- L18-SW1300V has 4Ω and L18-SW1300X has 8Ω impedance.
- Assembled in a strong and well vented octagonal shaped aluminium die-cast frame.
- Aluminium demodulating ring for enhanced heat dissipation. Special double treated cone for water splash resistance
- Heavy duty 12.7 cm (5") copper voice coil wound inside/outside on fibreglass former for withstanding high temperatures.
- Triple-rolled cloth surround with deep corrugations and double spider design to give better control of cone excursion.
- Ideal for usage in a wide variety of professional sub-woofer applications.

L18-SW1300X

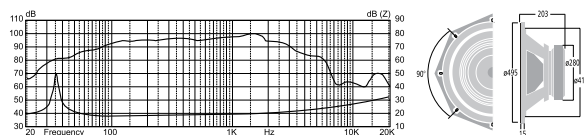

L18-SW1300V

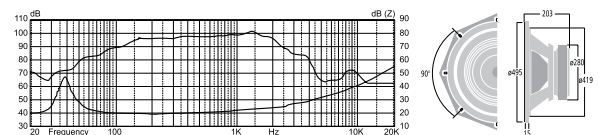

SPECIFICATIONS	L18-SW1000®	L18-SW1300V/ L18-SW1300X
POWER RATING	1000W RMS/2000W Programme	1300W RMS/2600W Programme
NOMINAL DIAMETER	457mm (18")	457mm (18")
NOMINAL IMPEDANCE	8Ω	4Ω/8Ω
SENSITIVITY (1W/1m)	99dB	97dB
MAGNET WEIGHT	5.65kg	5.65kg
RESONANT FREQUENCY (Fs)	36Hz	37Hz/35Hz
DC RESISTANCE (Re)	5.6Ω	3.6Ω/5.6Ω
ELECTROMAGNETIC Q (Qes)	0.32	0.27
MECHANICAL Q (Qms)	14.70	4.33/12.9
TOTAL Q (Qts)	0.31	0.25/0.26
COMPLIANCE EQUIVALENT VOLUME (VAS)	249 Litr	186 Litr/209 Litr
SURFACE AREA OF CONE (Sd)	1257cm ²	1257cm ²
REFERENCE EFFICIENCY (η ₀)	3.6%	3.5%/2.95%
VOICE COIL	5.0"	5.0"
OVERHANG (X _{max})	8.0 mm	8.0mm/8.0mm
MOVING MASS (M _{ms})	169gm	212gm/229gm
BL PRODUCT (BL)	26.0TM	25.8TM/32.0TM
COIL INDUCTANCE (Le)	1.91mH	1.3mH/1.73mH
OVERALL DIAMETER	477 mm	475 × 455 mm
DEPTH	202 mm	202 mm
BAFFLE HOLE DIAMETER	427 mm	422 mm
BOLT MOUNT DIAMETER (PCD)	451.5 mm (8 Bolts)	443 mm (8 Bolts)
WEIGHT	19.60kg	18.80kg





CD-50S 50 WATTS

Professional compression driver CD-50S, suitable for high power speakers. It features TITANIUM diaphragm EDGE WOUND copper clad aluminium ribbon wire voice coil and strontium ferrite magnet for high SPL & superb HF response. With a suitable horn it is ideal for use with low frequency speakers AHUJA L15-MB300, L15-MB400 and L15-MB500.

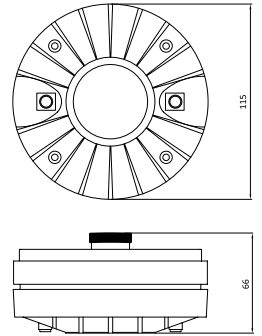

CD-80S 80 WATTS

Professional compression driver CD-80S, suitable for high power speakers. It features TITANIUM diaphragm EDGE WOUND copper clad aluminium ribbon wire voice coil and strontium ferrite magnet for high SPL & superb HF response. With a suitable horn it is ideal for use with low frequency speakers AHUJA L15-MB300, L15-MB400 and L15-MB500.

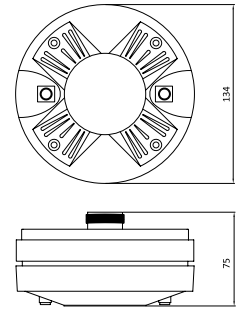

CD-100 100 WATTS



Professional compression driver CD-100, suitable for high power speakers. It features TITANIUM diaphragm EDGE WOUND copper clad aluminium ribbon wire voice coil and strontium ferrite magnet for high SPL & superb HF response. With a suitable horn it is ideal for use with low frequency speakers AHUJA L15-MB300, L15-MB400 and L15-MB500.

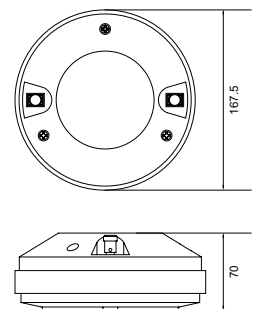

SPECIFICATIONS	CD-50S	CD-80S	CD-100
POWER CAPACITY	50W RMS	80W RMS	100W RMS
THROAT DIAMETER	25.4 mm (1")	25.4 mm (1")	50 mm (2")
NOMINAL IMPEDANCE	8Ω	8Ω	8Ω
SENSITIVITY (1W/1m)	106dB (with Horn)	108dB (with Horn)	108dB with (H-7380)
USABLE FREQUENCY RANGE	1,500-18,000Hz	1,500-18,000Hz	500Hz - 18,000Hz
RECOMMENDED CROSSOVER	2.5kHz 18dB/oct	2.5kHz 18dB/oct	1.2kHz 18 dB/oct
VOICE COIL DIAMETER	44.4 mm	44.4 mm (1.74")	72.2 mm (2.84")
DIAPHRAGM MATERIAL	Titanium	Titanium	Titanium
VOICE COIL MATERIAL	Edge Wound Copper Clad Aluminium Ribbon	Edge Wound Copper Clad Aluminium Ribbon	Edge Wound Aluminium Ribbon
VOICE COIL FORMER	Resin Bonded Kapton	Resin Bonded Kapton	Resin Bonded Nomex
THROAT COUPLING	1-3/8" 18TPI, Throat Couple No.1	1-3/8" 18TPI, Throat Couple No.1	—
OVERALL DIMENSIONS	Ø115 × H66 mm	Ø134 × H75 mm	Ø167.5 × H70 mm
WEIGHT	1.57kg	2.67kg	4.70kg

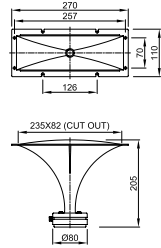

CDH-200 20 WATTS

Professional compression driver-horn CDH-200 loudspeaker, is suitable for medium power speaker systems. It is ideal for use in a 200W to 300W system. Can be combined with a single Low Frequency speaker like AHUJA L12-MB200, L15-MB300, to make an excellent medium power full range speaker system.

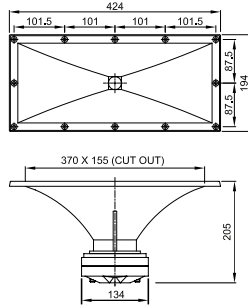

CDH-800 80 WATTS

Professional compression driver-horn CDH-800 loudspeaker, suitable for high power speaker systems. Owing to its titanium diaphragm the HF response is superb. Ideal for use with 2 nos. Low Frequency speakers AHUJA L15-MB300 to make a 600 watts speaker system. It can also be used with a single AHUJA L15-MB300 or L15-MB400 or L15-MB500. The solid glass filled ABS horn has a very even radiation and excellent sound. Thus it is ideal for all indoor as well as outdoor PA and professional DJ applications.

SPECIFICATIONS	CDH-200	CDH-800
POWER CAPACITY	20W RMS	80W RMS
THROAT DIAMETER	25.4 mm (1")	25.4 mm (1")
NOMINAL IMPEDANCE	8Ω	8Ω
SENSITIVITY (1W/1m)	105dB	108dB
USABLE FREQUENCY RANGE	3kHz-15kHz	1.5kHz-18kHz
RECOMMENDED CROSSOVER	4kHz 12dB/oct	2.5kHz 18dB/oct
VOICE COIL DIAMETER	25.4 mm	44.4 mm
DIAPHRAGM MATERIAL	Phenolic Resin	Titanium
VOICE COIL MATERIAL	Round Copper Wire	Edge Wound Copper Clad Aluminium Ribbon
VOICE COIL FORMER	Nomex	Resin Bonded Kapton
HORN MATERIAL	ABS with Glass Filled Black Polycarbonate	ABS with Glass Filled Black Polycarbonate
NOMINAL COVERAGE ANGLE	H100° x V80° (-5 dB)	H90° x V40° (-6dB)
HORN CUT OFF FREQUENCY	780Hz	600Hz
MOUNTING CUTOUT	W235 × H82 mm	W370 × H155 mm
OVERALL DIMENSIONS	W270 × H110 × D205 mm	W424 × H194 × D205 mm
WEIGHT	1.36kg	3.45kg

PA Piezo Horn Tweeters

AHUJA present a variety of compact and powerful piezo tweeters, driver and horn with extended high frequency response, low distortion and excellent power handling capacity. These are ideal for use with existing AHUJA range of 30.38 cm (12") and 38.1 cm (15") professional PA speakers.

APT-001

- Piezo tweeter.
- With horn front attachment for rear mounting.



APT-016

- Piezo tweeter.
- Compact rectangular form.



APT-025

- Rectangular high power piezo tweeter with deep low limit frequency



The piezo tweeters can be operated without a crossover network. However, it is recommended to connect a series resistor of about 20-50Ω (10-20W) or a metallised polyester capacitor of about 0.1-0.47mfd in order to avoid interfering effects and for proper matching of SPL levels with the woofer/full range speaker.

SPECIFICATIONS	APT-001	APT-016	APT-025
MAX. VOLTAGE	35V~	35V~	35V~
MUSIC POWER 4Ω/8Ω System	300W/ 150W	300W/ 150W	300W/ 150W
SPL (2.83V/1m)	94dB	91dB	92dB
FREQUENCY RESPONSE	4,000-20,000Hz	3,000-20,000Hz	1,800-20,000Hz
RADIATION ANGLE (V/H)	—	45° /90°	45° /90°
IMPEDANCE @ 1kHz	>1,000Ω	>1,000Ω	>1,000Ω
MOUNTING CUTOUT	73 mm	98 × 55 mm	155 × 58 mm
DIMENSIONS	85 × 85 mm	145 × 67 mm	187 × 80 mm
WEIGHT	65g	55g	100g



ACX-202

PA Active Crossover



A highly reliable, high performance 2 channel active crossover for use with the best cabinet speakers and subwoofers. Apart from top speakers in stereo mode, ACX-202 allows subwoofers to be connected in either stereo or mono mode.

- Full Stereo mode with Dual High & Low frequency outputs. Six selectable crossover frequencies. Extra sharp 24db / octave filter for very clear separation of frequency bands.
- Separate output for connecting subwoofer in mono mode, with 2 selectable crossover frequencies & 24db / octave filter.
- Separate input level controls for each channel, with LED indicator for clipping level.
- Phase Reversal Facility for Lo Outputs.
- XLR as well as TRS connectors for balanced inputs & outputs.

SPECIFICATIONS	ACX-202
INPUT SENSITIVITY	1V/20k Ω
LOW, HIGH OUT FILTER SLOPE	24dB/Oct
THD	<0.01%
CROSSOVER FREQUENCIES	For Stereo Mode: 60Hz, 80Hz, 100Hz, 120Hz, 180Hz, 250Hz / For Sub MONO Mode: 80Hz, 120Hz
FREQUENCY RANGE	20Hz to 20kHz
SIGNAL TO NOISE RATIO	85dB
INDICATIONS	Power ON LED, Clip LED
POWER SUPPLY	AC: 240V 50Hz
PROTECTION	AC: Fuse 1Amp. (T 1A L)
DIMENSIONS	W483 × H52 × D231 mm
WEIGHT	2.85kg

Passive Crossovers

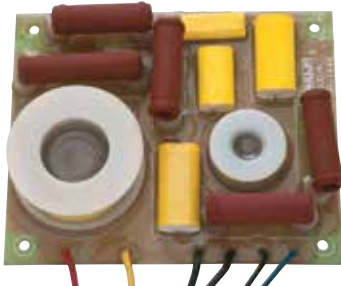
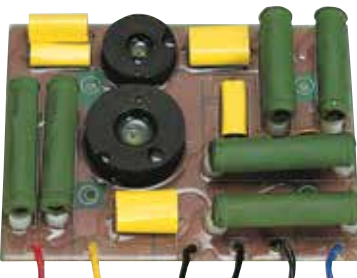
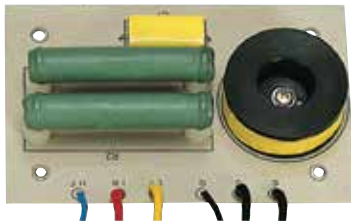

C-300/200 300W RMS

- Professional 2-Way Passive Crossover Network.
- Designed for use with 1 no. LF woofer AHUJA model L15-MB300, L12-MB300 or L12-MB200.
- HF driver CDH-200.
- High power and Low resistance Air core coils.
- High quality metallised polyester capacitors.

C-350/450 350W RMS

- Professional 2-Way Passive Crossover Network.
- Designed for use with 1 no. LF woofer AHUJA model L15-MB300 or L12-MB300.
- HF driver CDH-800.
- PTC for HF protection.
- High power and Low resistance Air core coils.
- High quality metallised polyester capacitors.

C-500/450 500W RMS

- Professional 2-Way Passive Crossover Network.
- Designed for use with 1 no. LF woofer AHUJA model L15-MB400 or L15-MB500.
- HF driver CDH-800.
- PTC for HF protection.
- High power and Low resistance Air core coils.
- High quality metallised polyester capacitors.

SPECIFICATIONS	C-300/200	C-350/450	C-500/450
TYPE	Two-Way Crossover	Two-Way Crossover	Two-Way Crossover
POWER CAPACITY	300W	350W	500W
CROSSOVER FREQUENCY	4kHz	2kHz	2.5kHz
NOMINAL IMPEDANCE	8 Ω	8 Ω	8 Ω
LOW PASS FILTER SLOPE	—	12dB/Octave	12dB/Octave
HIGH PASS FILTER SLOPE	12dB/Octave	18dB/Octave with protection	18dB/Octave with protection
DIMENSIONS	W146 x H32 x D95 mm	W187 x H32 x D141 mm	W170 x H32 x D140 mm
WEIGHT	335g	630g	625g

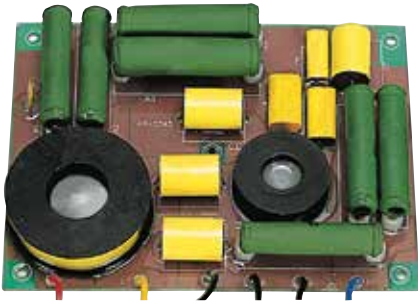

C-500/750 500W RMS

- Professional 2-Way Passive Crossover Network.
- Designed for use with 1 no. LF woofer AHUJA Model L15-MB500.
- HF driver CDH-1000.
- PTC for HF protection.
- High power and Low resistance Air core coils.
- High quality metallised polyester capacitors.

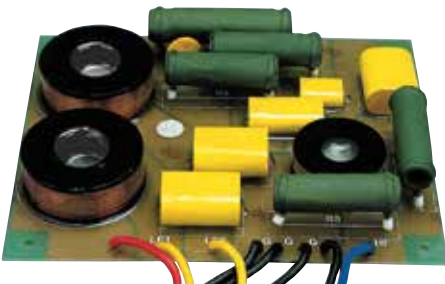

C-600/450 600W RMS

- Professional 2-Way Passive Crossover Network.
- Designed for use with 2 nos. LF woofer AHUJA Model L15-MB300 or L12-MB300.
- HF driver CDH-800.
- PTC for HF protection.
- High power and Low resistance Air core coils.
- High quality metallised polyester capacitors.



C-650/750 650W RMS

- Professional 2-Way Passive Crossover Network.
- Designed for use with 1 nos. LF woofer AHUJA Model L15-MB500 or L15-MB650.
- HF driver CDH-1000.
- PTC for HF protection.
- High power and Low resistance Air core coils.
- High quality metallised polyester capacitors.



C-1000/450 1000W RMS

- Professional 2-Way Passive Crossover Network.
- Designed for use with 2 nos. LF woofer AHUJA model L15-MB400 or L15-MB500.
- HF driver CDH-800.
- PTC for HF protection.
- High power and Low resistance Air core coils.
- High quality metallised polyester capacitors.

SPECIFICATIONS	C-500/750	C-600/450	C-650/750	C-1000/450
TYPE	Two-Way Crossover	Two-Way Crossover	Two-Way Crossover	Two-Way Crossover
POWER CAPACITY	500W	600W	650W	1000W
CROSSOVER FREQUENCY	1.2kHz	2.5kHz	1.2kHz	2.5kHz
NOMINAL IMPEDANCE	8Ω	4Ω	8Ω	4Ω
LOW PASS FILTER SLOPE	12dB/Octave	12dB/Octave	12dB/Octave	12dB/Octave
HIGH PASS FILTER SLOPE	18dB/Octave with protection	18dB/Octave with protection	18dB/Octave with protection	18dB/Octave with protection
DIMENSIONS	W225 x H35 x D169 mm	W180 x H32 x D150 mm	W227 x H43 x D190 mm	W220 x H35 x D166mm
WEIGHT	1.11kg	805g	1.20kg	1.01kg



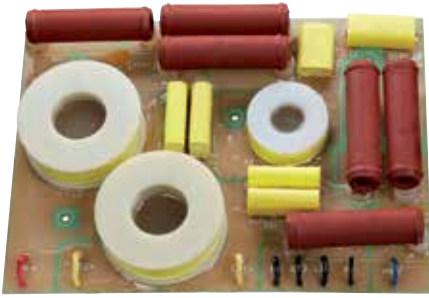

C-1300/750 1300W RMS

- Professional 2-Way Passive Crossover Network.
- Designed for use with 2 nos. LF woofer AHUJA Model L15-MB500 or L15-MB650.
- HF driver CDH-1000.
- PTC for HF protection.
- High power and Low resistance Air core coils.
- High quality metallised polyester capacitors.

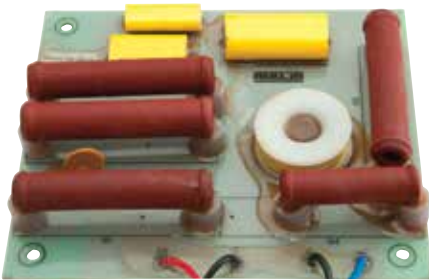

C-80HF 500W RMS

- Professional 1-Way Passive HF Crossover Network for HF Driver.
- Designed for use with 2-Way Speaker System using 1 no. compression driver AHUJA model CDH-800 or CD-80S.
- High power and Low resistance coils.
- High quality metallised polyester capacitors.



C-100HF 1300W RMS

- Professional 1-Way Passive HF Crossover Network for HF Driver.
- Designed for use with 2-Way Speaker System using 1 no. compression driver AHUJA model CDH-1000.
- High power and Low resistance coils.
- High quality metallised polyester capacitors.

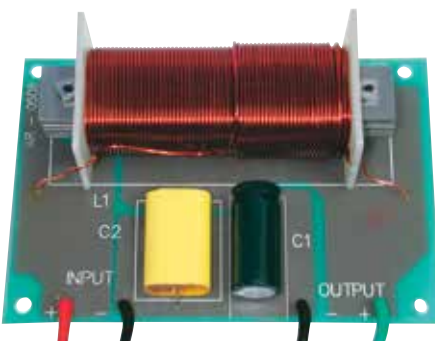

C-650SW 650W RMS

- Professional 1-Way Passive LF Crossover Network.
- Designed for use with 1 no. subwoofer AHUJA model L18-SW650.
- Also usable with 1 no. Subwoofer system AHUJA model SWX-650.
- High power and Low resistance coils.
- High quality metallised polyester capacitors.

SPECIFICATIONS	C1300/750	C-80HF	C-100HF	C-650SW
Type	Two-Way Crossover	HF Crossover	HF Crossover	Subwoofer Crossover
POWER CAPACITY	1300W	500W	1300W	650W
CROSSOVER FREQUENCY	1.2kHz	2.5kHz	1.2kHz	250Hz
NOMINAL IMPEDANCE	4Ω	8Ω	8Ω	8Ω
LOW PASS FILTER SLOPE	12dB/Octave	—	—	12dB/Octave
HIGH PASS FILTER SLOPE	18dB/Octave with protection	18dB/Octave with protection	18dB/Octave with protection	—
DIMENSIONS	W260 x H43 x D192	W161 x H32 x D140mm	W183 x H43 x D150 mm	W140 x H32 x D95 mm
WEIGHT	1.72kg	355g	622g	675g



Hallmark of Reliability!



Portable PA

Convenient, Compatible & Complete:

AHUJA Portable PA Equipment are attractive, ready to use amplifier and speaker all supplied in one integrated package.

Applications

Tour Guides | Traffic Police | Class Rooms | Mobile Announcements

Religious Discourses | Private Parties | Clubs & Community Centers

XPA-3010DP

250 WATTS



Rear Panel



XPA-3010DP has a built-in Power Amplifier with multiple inputs for use in a wide variety of PA and Musical Programmes. Feature packed XPA-3010DP is an ideal equipment for small as well as medium gatherings of around 200 people. Applications include Music and Vocal Performances, Conferences and Lectures, Presentations, Religious Discourses and Gatherings, Stage Monitors, Touring PA, Mini-Theatres, Pubs and Bars etc.

- 3 Microphone Inputs with MIC1 Priority.
- Inputs for CD & Aux sources, Line Input.
- Line out to link another XPA-3010DP, or for recording on a computer, record player.
- 2-Way Speaker System 30.4 cm (12") LF Woofer \varnothing 6.3 cm (2.5") voice coil + Dynamic Horn \varnothing 4.4 cm (1.75") voice coil.
- Built-in MP3 player with USB, SD/MMC card reader, bluetooth facility & remote control.
- For using wireless microphone systems, 12V DC output is available for connecting a wireless receiver.
- Moulded Cabinet PA Active Loudspeaker.

SPECIFICATIONS	XPA-3010DP
POWER OUTPUT	250W RMS at 1% THD 200W RMS at 0.5% THD
OUTPUT REGULATION	$\leq 0.5\text{dB}$, no load to full load at 1kHz
INPUT CHANNELS	3 \times Mic 2.0mV/4.7k Ω , 1 \times Aux 250mV/470k Ω , Line in: 1V/10k Ω
FREQUENCY RESPONSE	35-20,000Hz $\pm 3\text{dB}$
SIGNAL TO NOISE RATIO	60dB
TONE CONTROLS	Bass: $\pm 5\text{dB}$ at 100Hz, Treble: $\pm 5\text{dB}$ at 10kHz
LINE OUTPUT	1V/1k Ω
DIGITAL PLAYER	MP3 Player with USB, SD/MMC Card reader and Bluetooth
PROTECTIONS	AC: Fuse 1 \times 4A (T 4A L) DC: 2 \times 6A Fuse (T 6A L)
POWER SUPPLY	AC: 220-240V 50/60 Hz
DC OUTPUT	12V/500mA
AC POWER CONSUMPTION	300VA
DIMENSIONS	W385 \times H585 \times D305 mm
WEIGHT	21.00kg

XPA-1510DP

125 WATTS



Rear Panel

XPA-1510DP has a built-in Power Amplifier with multiple inputs for use in a wide variety of PA and Musical Programmes. Feature packed XPA-1510DP is an ideal equipment for small as well as medium gatherings of around 100 people. Applications include Music and Vocal Performances, Conferences and Lectures, Presentations, Religious Discourses and Gatherings, Stage Monitors, Touring PA, Mini-Theatres, Pubs and Bars etc.

- 3 Microphone Inputs with MIC1 Priority.
- Inputs for CD & Aux sources, Line Input.
- Line out to link another XPA-1510DP, or for recording on a computer.
- 2-Way Speaker System 25.4 cm (10") LF Woofer (ø 5.0 cm (2") voice coil + Dynamic Horn (ø2.5 cm (1.0") voice coil.
- Built-in MP3 player with USB, SD/MMC card reader, bluetooth facility & remote control.
- For using wireless microphone systems, 12V DC output is available for connecting a wireless receiver.
- Moulded Cabinet PA Active Loudspeaker.

PSX-302DP

15 WATTS



PSX-302DP features a built-in rechargeable 7.2Ah battery and a suitable, well designed circuit for charging the battery from AC mains. Low Battery LED indication is provided, along with a circuit to prevent deep discharge of the battery. The built-in battery makes the PSX-302DP Portable PA System truly versatile, allowing it to be carried and operated anywhere. It is ideal for outdoor meetings, coaching classes, lecture halls, presentations, exhibitions, field publicity etc.

- 15W Portable Public Address Equipment.
- Mic & Aux inputs with Tone control.
- 16.5 cm (6.5") 6 ohm dual cone full range speaker.
- Fitted with a handle for easy transportation.
- Three power source operation: AC Mains, 12V external battery, or built-in 12V rechargeable battery.
- Built-in MP3 player with remote control.

SPECIFICATIONS	XPA-1510DP	PSX-302DP
POWER OUTPUT	125W RMS at 1% THD 100W RMS at 0.5% THD	15W RMS at 10% THD 10W RMS at 1% THD
OUTPUT REGULATION	≤ 0.5dB, no load to full load at 1kHz	≤ 2dB
INPUT CHANNELS	3 × Mic 2.0mV/4.7kΩ, 1 × Aux 250mV/470kΩ, Line in: 1V/10kΩ	2 × Mic 1.5mV/4.7kΩ 1 × Aux 100 mV/330kΩ
FREQUENCY RESPONSE	40-20,000Hz ± 3dB	120-15,000Hz ± 3dB
SIGNAL TO NOISE RATIO	60dB	60dB
TONE CONTROLS	Bass: ±5dB at 100Hz, Treble: ±5dB at 10kHz	-10dB at 10kHz
PREAMP OUTPUT	—	200mV/600Ω
LINE OUTPUT	1V/1kΩ	—
DIGITAL PLAYER	MP3 Player with USB, SD/MMC Card reader and Bluetooth	MP3 Player with USB
PROTECTIONS	AC: Fuse 1 × 3A (T 3A L) DC: 2 × 5A Fuse (T 5A L)	Fuse AC 1A, DC 4A
POWER SUPPLY	AC: 220-240V 50/60 Hz	AC : 220V-240V 50/60Hz DC: 12V (12V Car Battery) and 12V Built-in rechargeable battery
DC OUTPUT	12V/500mA	—
AC POWER CONSUMPTION	250VA	50VA
DIMENSIONS	W325 × H485 × D255 mm	W245 x H345 x D175 mm
WEIGHT	13.50kg	8.20kg



Bi-Amp PA Active Loudspeakers

ABA-5000

400 WATTS



Rear Panel



ABA-5000 has a built-in Bi-Amplifier for woofer and HF driver separately, for use in a wide variety of Professional and PA Programmes. Feature packed ABA-5000 is an ideal equipment for applications such as in Professional Music and Vocal Performances, Touring PA, Mini-Theatres, Pubs and Bars, Religious Gatherings, Stage Monitors etc.

- 1xBalanced Mic/Line Input selectable through a push switch.
- 1xLine Input can be used for connecting balanced MONO signal through jack or unbalanced STEREO signal source through dual RCA.
- Switchable balanced output either as a Loop through output of Input-1 or a mix output of Input-1 and 2.
- Balanced output to link another ABA-5000 or for recording on a computer, record player.
- 2-Way Speaker System: 38.1 cm (15") LF Woofer \varnothing 7.6 cm (3.0") voice coil + Dynamic Horn \varnothing 4.4 cm (1.75") voice coil.
- Moulded Cabinet Bi-Amp PA Active Loudspeaker.

SPECIFICATIONS	ABA-5000
POWER OUTPUT (Bi-AMP)	LF: 350W RMS at 1% THD Class H, HF: 50W RMS at 1% THD Class AB
OUTPUT REGULATION	≤ 0.5 dB, no load to full load at 1kHz
INPUT CHANNELS	INPUT-1: MIC 20mV/3k Ω balanced, LINE: 775mV/10k Ω balanced, INPUT-2: LINE (Jack) 250mV/20k Ω balanced, RCA: 250mV (L&R)/10k Ω
FREQUENCY RESPONSE	50-20,000Hz ± 3 DB
CROSSOVER FREQUENCY	2.5kHz, Filter Slope 24dB per octave
SIGNAL TO NOISE RATIO	60dB
TONE CONTROLS	Bass: ± 5 dB at 100Hz, Treble: ± 5 dB at 10kHz
OUTPUT	(a) Loop through (INPUT-1): 20mV or 775mV (b) Mixed Output (1+2): 775mV/1k Ω
PROTECTIONS	AC: Fuse 1x5A (T 5A L) DC: Fuse 2x8A (T 8A L)
POWER SUPPLY	AC: 220-240V 50/60Hz
AC POWER CONSUMPTION	500VA
DIMENSIONS	W450 X H690 X D360 mm
WEIGHT	28.10kg

ABA-4000

325 WATTS



Rear Panel

ABA-4000 has a built-in Bi-Amplifier for woofer and HF driver separately, for use in a wide variety of Professional and PA Programmes. Feature packed ABA-4000 is an ideal equipment for applications such as in Professional Music and Vocal Performances, Touring PA, Mini-Theatres, Pubs and Bars, Religious Gatherings, Stage Monitors etc.

- 1 × Balanced Mic/Line Input selectable through a push switch.
- 1 × Line Input can be used for connecting balanced MONO signal through jack or unbalanced STEREO signal source through dual RCA.
- Switchable balanced output either as a Loop through output of Input-1 or a mix output of Input-1 and 2.
- Balanced output to link another ABA-4000 or for recording on a computer, record player.
- 2-Way Speaker System: 30.4 cm (12") LF Woofer \varnothing 6.3 cm (2.5") voice coil + Dynamic Horn \varnothing 4.4 cm (1.75") voice coil).
- Moulded Cabinet Bi-Amp PA Active Loudspeaker.

SPECIFICATIONS	ABA-4000
POWER OUTPUT (Bi-AMP)	LF: 275W RMS at 1% THD Class H, HF: 50W RMS at 1% THD Class AB
OUTPUT REGULATION	$\leq 0.5\text{dB}$, no load to full load at 1kHz
INPUT CHANNELS	INPUT-1: MIC 20mV/3k Ω balanced, LINE: 775mV/10k Ω balanced, INPUT-2: LINE (Jack) 250mV/20k Ω balanced, RCA: 250mV (L&R)/10k Ω
FREQUENCY RESPONSE	50-20,000Hz $\pm 3\text{dB}$
CROSSOVER FREQUENCY	2kHz, Filter Slope 24dB per octave
SIGNAL TO NOISE RATIO	60dB
TONE CONTROLS	Bass: $\pm 5\text{dB}$ at 100Hz, Treble: $\pm 5\text{dB}$ at 10kHz
OUTPUT	a) Loop through (INPUT-1): 20mV or 775mV b) Mixed Output (1+2): 775mV/1k Ω
PROTECTIONS	AC: Fuse 1 \times 4A (T 4A L) DC: Fuse 2 \times 6A (T 6A L)
POWER SUPPLY	AC: 220-240V 50/60 Hz
AC POWER CONSUMPTION	375VA
DIMENSIONS	W385 \times H585 \times D305 mm
WEIGHT	20.80kg



PA Amplifier Sets

BTA-880 50 WATTS



- Elegant and stylish looking plastic moulded cabinet PA Amplifier Set with Trolley System.
- Two Mic inputs, Two Wireless Mics, one Aux input & one Music input. Mic1 has selectable priority over all other inputs.
- Built-in 30.4 cm (12") 4Ω speaker & 8Ω HF driver.
- Built-in MP3 Player with Bluetooth, Recorder, SD Card and Remote Control. Built-in Digital Echo effects.
- Tone control for setting the desire tonal quality.
- LED indications for low battery, charging & clip output. Auto cut-off feature prevents battery deep discharge.
- Operates on AC mains, external 12V DC or built-in 12V 7Ah rechargeable battery.

SPECIFICATIONS	AMPLIFIER
AUDIO OUTPUT (BI-AMP)	50W Max.
INPUT CHANNELS	2 x Mic 3mV/4.7kΩ, 1 x Aux 100 mV/47kΩ, Music 100mV/47kΩ, 2 x Wireless MIC
PREAMP OUTPUT	200mV/600Ω
TONE CONTROLS	Bass ±5dB at 100Hz, Treble ±5dB at 10kHz
DIGITAL PLAYER	MP3 player with USB, SD, MMC card reader, Recording function and Bluetooth.
POWER REQUIREMENTS	AC : 220V-240V 50/60Hz DC : 12V Car Battery (external), 12V 7Ah Rechargeable Battery (built-in)
POWER CONSUMPTION	60VA
PROTECTION	AC Fuse: 1A 250V (T 1A L)
WIRELESS RECEIVING MODE	Quartz Controlled Fixed Frequency
WIRELESS RANGE	Over 20m in Free Space (Line of Sight)
DIMENSION	W405 x H610 x D350 mm
WEIGHT	18.80kg
SPECIFICATIONS	TRANSMITTER
RF OUTPUT POWER	10mW (Max.)
MAX. MODULATION	45dB
FREQUENCY RESPONSE	50-15,000Hz
BATTERY	3V (2 × 1.5V AA Pencil Cells)
DIMENSION	Ø52 × L242 mm
WEIGHT	140g (without battery)

BTA-660

40 WATTS



- Elegant and stylish looking plastic moulded cabinet PA Amplifier Set with Trolley System.
- Two Mic inputs, Two Wireless Mics, one Aux input & one Music input. Mic1 has selectable priority over all other inputs.
- Built-in 25.4 cm (10") 4Ω speaker & 8Ω HF driver.
- Built-in MP3 Player with Bluetooth, Recorder, SD Card and Remote Control. Built-in Digital Echo effects.
- Tone control for setting the desire tonal quality.
- LED indications for low battery, charging & clip output. Auto cut-off feature prevents battery deep discharge.
- Operates on AC mains, external 12V DC or built-in 12V 7Ah rechargeable battery.

SPECIFICATIONS	AMPLIFIER
AUDIO OUTPUT (BI-AMP)	40W Max.
INPUT CHANNELS	2 x Mic 4mV/4.7kΩ, 1 x Aux 100 mV/47kΩ, Music 100mV/47kΩ, 2 x Wireless MIC
PREAMP OUTPUT	200mV/600Ω
TONE CONTROLS	Bass ±5dB at 100Hz, Treble ±5dB at 10kHz
DIGITAL PLAYER	MP3 player with USB, SD, MMC card reader, Recording function and Bluetooth.
POWER REQUIREMENTS	AC : 220V-240V 50/60Hz DC : 12V Car Battery (external), 12V 7Ah Rechargeable Battery (built-in)
POWER CONSUMPTION	50VA
PROTECTION	AC Fuse: 1A 250V (T 1A L)
WIRELESS RECEIVING MODE	Quartz Controlled Fixed Frequency
WIRELESS RANGE	Over 20m in Free Space (Line of Sight)
DIMENSION	W325 x H550 x D280 mm
WEIGHT	14.30kg
SPECIFICATIONS	TRANSMITTER
RF OUTPUT POWER	10mW (Max.)
MAX. MODULATION	45dB
FREQUENCY RESPONSE	50-15,000Hz
BATTERY	3V (2 × 1.5V AA Pencil Cells)
DIMENSION	Ø52 × L242 mm
WEIGHT	140g (without battery)



PA Amplifier Sets

WP-220M 20 WATTS



WM-22

Or



WM-23

A truly portable, highly versatile and attractive 20 Watts Max. PA Wireless Amplifier Set WP-220M. Ideal for various Indoor and Outdoor applications such as Small Gatherings, Presentations, Performances, Bus Tours, Classrooms etc.,

- Supplied with Handheld wireless microphone model WM-22 or Headband microphone WM-23 available in different frequencies.
- Built-in digital MP3 player, recorder and Bluetooth facility.
- Digital echo effects provided.
- Wired Mic input has priority.
- Provision for connecting one wired microphone & an AUX source like a CD player or Mixer using 3.5mm phone jack.
- Tone control provided for adjusting the tone settings.
- Operates on AC mains, 12V external car battery & 11.1V/2.2Ah internal rechargeable battery.
- Facility for recharging a 11.1V/2.2Ah internal battery and 8.4V rechargeable battery for handheld transmitter.
- 8 Ohm speaker output for connecting an external speaker.

SPECIFICATIONS	AMPLIFIER
AUDIO OUTPUT	20W Max.
INPUT CHANNELS SENSITIVITY	Mic 6mV, Aux 200mV
AUX OUTPUT	400mV
USB/SD PLAYER	MP3 and WMA format
POWER REQUIREMENTS	AC 220-240V, 50/60Hz DC 12-15V Car Battery, 11.1V/2.2Ah Rechargeable Battery
POWER CONSUMPTION	AC: 35W, DC: 2A
PROTECTION	DC Fuse T 3A/250V
WIRELESS RECEIVING MODE	Quartz Controlled Fixed Frequency
WIRELESS RANGE	Over 20m in Free Space (Line of Sight)
DIMENSION	W200 × H295 × D122 mm
WEIGHT	2.60kg

SPECIFICATIONS	WM-22	WM-23
RF OUTPUT POWER	10mW (Max.)	10mW (Max.)
MAX. MODULATION	45dB	45dB
FREQUENCY RESPONSE	50-15,000Hz	50-15,000Hz
BATTERY	1 × 9V Battery	3V
DIMENSION	∅52 × L242 mm	L65 × W35 × H105 mm
WEIGHT	150g (without battery)	90g (without battery)



NBA-30WL

10 WATTS ■ Neckband PA Amplifier Set

- Elegant and compact Portable PA amplifier with max. output power 10W.
 - Built-in high capacity rechargeable battery, 4hrs charging lasts for more than 10hrs operation.
 - UHF wireless transmission technology, long operation range.
 - Rare earth material speaker, light weight, wonderful sound, high volume.
 - Wireless playing function to link with cell phone/PC/I Pad to play music.
 - TF card for audio playing in MP3/WAV format. Recording function to record audio file in WAV format.
 - Automatic FM stations searching, saving more than 50 channels.
 - Supplied with a headband microphone, a neck strap and an USB micro charging cable (for recharging the built-in rechargeable battery only).
 - 3.5mm Mic input socket for connecting the headband microphone and a 3.5mm Line input socket for connecting a DVD, CD or an MP3 player.
- Ideal for: [Teaching](#), [Tour Guides](#), [Yoga Classes](#), [Play Schools](#) and [Small Group Presentations](#).



NBA-20DP

12 WATTS ■ Neckband PA Amplifier Set

- Elegant and compact ultra portable PA Amplifier Set with max. output power of 12W.
 - Built-in MP3 digital player for playback of music through a USB drive or a TF card.
 - Special circuitry provides low distortion even at high output power. Built-in high capacity rechargeable battery. Low battery LED indicator.
 - Ø 3.5mm Mic input socket for connecting the headband microphone and 3.5mm Line input socket for connecting a DVD, CD or an MP3 player.
 - Apart from the headband mic provided, the mic input socket can also accept input from Ahuja Condenser Microphones CTP-10DX, UTP-30 (used without their cell compartment).
 - Convenience of use. The unit can be used while hanging on the shoulder or by putting around the neck.
- Ideal for: [Teaching](#), [Tour Guides](#), [Yoga Classes](#), [Play Schools](#) etc. ...

NBA-15

12 WATTS ■ Neckband PA Amplifier Set

- Elegant and compact ultra portable PA Amplifier Set with max. output power of 12W.
 - Special circuitry provides low distortion even at high output power. Built-in high capacity rechargeable battery. Low battery LED indicator.
 - Ø 3.5mm Mic input socket for connecting the headband microphone and 3.5mm Line input socket for connecting a DVD, CD or an MP3 player.
 - Convenience of use. The unit can be used while hanging on the shoulder or by putting around the waist.
- Ideal for: [Teaching](#), [Tour Guides](#), [Yoga Classes](#), [Play Schools](#) etc. ...



SPECIFICATIONS	NBA-30WL	NBA-20DP	NBA-15
POWER OUTPUT	10W Max.	12W Max.	12W Max.
SPEAKER IMPEDANCE	4Ω	4Ω	4Ω
INPUT CHANNEL	Mic, Aux	Mic-1: 1.0mV, Line: 250mV	Mic-1: 1.0mV, Line: 250mV
DIGITAL PLAYER	TF Card (64GB max.)	USB & TF Card (16GB max.)	—
FREQUENCY RESPONSE	80-12,000Hz	80-12,000Hz	80-12,000Hz
AC ADAPTER	—	AC: 100-240V, 50/60HZ; DC: 5V, 750mA	AC: 100-240V, 50/60HZ; DC: 5V, 750mA
RECHARGEABLE BATTERY	3.7V, 2000mAh	3.7V, 2000mAh	3.7V, 2000mAh
HEADBAND MICROPHONE ELEMENT	Condenser, Unidirectional	Condenser, Cardioid	Condenser, Cardioid
DIMENSIONS	W113 × H84 × D44 mm (amplifier only)	W86 × H98 × D44 mm (amplifier only)	W86 × H98 × D44 mm (amplifier only)
WEIGHT (with rechargeable battery)	200g (amplifier only)	340g (amplifier only)	340g (amplifier only)



2-Way Array Active Loudspeakers

VIVA-600

525 WATTS



Compact and elegant Class-D Bi-Amp Active Loudspeakers with 400W RMS for LF and 125W RMS for HF. Built-in preset equalizer with NORMAL, JAZZ, CLASSIC, & POP modes. Ideal for indoor live music performances and small gatherings.

- High quality class D amplifier with digital processor.
- Equalizer setting of NORMAL mode has provision to cut & boost gain for 5 frequencies 80Hz, 330Hz, 1.2kHz, 3.3kHz & 12kHz.
- Integrated satellite 3x cylindrical speaker columns, directly fittable on Subwoofer cabinet without hassle of speaker wiring.
- Rear panel control consists of LCD digital display to view & set the features in use.
- Built-in Bluetooth for playing music.
- 2 x combo input connectors (TRS/XLR) for Mic or Line input.
- Built-in fixed limiter: 6dB for LF & 18dB for HF provided for protection.
- Ease of operation combined with service accessibility has been optimized in design.



SPECIFICATIONS	VIVA-600	
	LF	HF
POWER OUTPUT	400W RMS at < 1% THD	125W RMS at < 1% THD
SENSITIVITY	Line: 450mV	450mV
	Mic: 10mV	10mV
OUTPUT	XLR Mixed Output	
EQUALIZER	NORMAL, CLASSIC, JAZZ, POP	
LIMITER	6dB	18dB
SETTING FOR NORMAL EQ.	EQ.-1 80Hz : -8dB to +3dB, EQ.-2 330Hz : -8dB to +5dB, EQ.-3 1.2kHz : -8dB to +5dB, EQ.-4 3.3kHz : -8dB to +5dB, EQ.-5 12kHz : -8dB to +5dB	
SPEAKER	304.8 mm (12") Subwoofer	8 x 76.2 mm (3") Speaker
FREQUENCY RESPONSE	30Hz-160Hz	160Hz-20kHz
MP3 PLAYBACK	Via Bluetooth	
SIGNAL TO NOISE RATIO	80dB	
POWER SUPPLY	AC : 220-240V 50/60Hz	
PROTECTION	AC: Fuse 3.15Amp.	
AC POWER CONSUMPTION	650 VA	
DIMENSIONS	Subwoofer: W385 × H485 × D520 mm, Satellite (Top): W85 × H495 × D112 mm,	
	Satellite (Mid. & Bottom): W85 × H515 × D112 mm	
WEIGHT	Subwoofer: 20.80kg, Satellite: 1.30+1.30+1.10kg	

WSL-2500R

40 WATTS PA Amplifier Set

- Compact, versatile and easy-to-assemble wireless Lectern Amplifier with built in 40W amplifier.
- Contains a built-in speaker consisting of 3nos. 16.5 cm (6.5") coated dual cone speakers. Provision given for connecting external speaker, if required.
- Supplied with a detachable gooseneck condenser microphone and a reading light for the podium top.
- Contains a built-in VHF wireless diversity receiver. High quality VHF handheld wireless transmitter supplied. (Available in different frequencies).
- Provision for connecting a wired microphone through an XLR connector or a line source through a 6.3mm phone jack.
- Handheld wireless transmitter & gooseneck podium microphone have voice priority over all other inputs. This feature can be switched ON or OFF through a slide switch.
- Built in digital recorder cum MP3 player, which can record on USB pen drives or SD cards.
- Facility for connecting a stereo auxiliary source through L&R RCA plug. It accepts four different sensitivities of auxiliary signal which are selectable through a slide switch.
- Seperate output connectors for LINE OUT & REC OUT through mini male XLR & 6.3mm phone socket respectively, allowing the lectern system to be connected to external amplifiers for further amplification, if required.
- Tonal adjustment can be done through cut-boost type Bass & Treble controls.
- Rugged & stable floor standing base. Can be fixed to the floor with brackets (provided), if required.
- Operates on 240V 50Hz mains supply.
- Some assembly by the customer required.



RECEIVER AMPLIFIER	
POWER OUTPUT	40 Watts Max.
SPEAKER IMPEDANCE (External)	4Ω
INPUT CHANNELS SENSITIVITY	Mic-1: 3.0mV
	Mic-2: 1.8mV, Line: 100mV,
	Aux Position-1: 100mV, Aux Position-2: 180mV,
	Aux Position-3: 300mV, Aux Position-4: 700mV
FREQUENCY RESPONSE	100-16,000Hz
TONE CONTROL	Bass: ±6dB at 80Hz, Treble: ±6dB at 8kHz
REC. OUTPUT	1V (nominal)
POWER SUPPLY	AC 220-240V, 50/60Hz
POWER CONSUMPTION	AC 100W
DIMENSIONS	W420 × H1135 × D580 mm
WEIGHT	18.30kg

HANDHELD WIRELESS TRANSMITTER	
MICROPHONE	Dynamic Unidirectional
FREQUENCY STABILITY	±0.005%
SPURIOUS EMISSIONS	45dB (max.)
RF OUTPUT POWER	15mW (max.)
FREQUENCY RESPONSE	50 - 15,000Hz
DYNAMIC RANGE	100dB
BATTERY	9V
DIMENSIONS	∅55 × L244 mm
WEIGHT	200g (without battery)





CLASS
D

AM-24DP

20 WATTS ■ Shoulder Sling & Hand Grip Type **NEW!**

- Dry Cells & Car Battery (12-14V DC) operation.
- CLASS-D AMPLIFIER provides extremely high efficiency of power consumption resulting in extended battery life.
- All ABS body, sturdy yet lightweight.
- Built-in Siren.
- MP3 playback facility through USB, SD / MMC Card & AUX input.
- Clear sound, long range & efficient.
- Microphone with Volume Control & built-in Recording/Playback facility. Message upto 240 Seconds (4 minutes) can be recorded.
- Additional microphone switch is provided in the hand grip.



CLASS
D

AM-22HSD

20 WATTS ■ Shoulder Sling & Hand Grip Type

- Operates on UM-3 (AA) Pencil Cells & Car Battery 12-14V DC.
- CLASS-D AMPLIFIER provides extremely high efficiency of power consumption resulting in extended battery life.
- All ABS body, sturdy yet lightweight.
- Built-in Siren.
- Clear sound, long range & efficient design.
- Microphone with Volume Control & Press-to-Talk Switch.
- Additional microphone switch is provided in the hand grip.



CLASS
D

AM-21®SD

20 WATTS ■ Shoulder Sling Type

- Operates on UM-2 Dry Cells & Car Battery 12-14V DC.
- CLASS-D AMPLIFIER provides extremely high efficiency of power consumption resulting in extended battery life.
- All ABS body, sturdy yet lightweight.
- Built-in Siren.
- Clear sound, long range & efficient design.
- Microphone with Volume Control & Press-to-Talk Switch.

SPECIFICATIONS	AM-24DP	AM-22HSD	AM-21®SD
POWER OUTPUT	16W Rated/20W Max.	16W Rated/20W Max.	16W Rated/20W Max.
VOICE RANGE	Approx. 400m (Siren 500m) In Quiet Surroundings	Approx. 400m (Siren 500m) In Quiet Surroundings	Approx. 400m (Siren 500m) In Quiet Surroundings
POWER SOURCE	8 × UM-2 Cells Car Battery 12-14V DC	10 × AA Pencil Cells Car Battery 12-14V DC	8 × UM-2 Cells Car Battery 12-14V DC
MICROPHONE	Unidirectional	Unidirectional	Unidirectional
INPUTS	Dedicated Microphone	Dedicated Microphone	Dedicated Microphone
DIMENSIONS	Horn Ø230mm, L382 mm	Horn Ø220mm, L370 mm	Horn Ø220mm, L370 mm
WEIGHT	1.10kg (without cells)	1.90kg (without cells)	1.90kg (without cells)



AM-20HD

20 WATTS ■ Hand Grip Type

- Operates on UM-2 Dry Cells & Car Battery 12-14V DC.
- CLASS-D AMPLIFIER provides extremely high efficiency of power consumption resulting in extended battery life.
- All ABS body, sturdy yet lightweight.
- Built-in Siren & Microphone.
- Clear sound, long range & efficient design.
- Conveniently located Volume Control & Switch.



CLH-33

10 WATTS ■ Compact Loud Hailer

- Compact and Lightweight Megaphone. Ergonomic Design - Easy to Hold & Carry. Transparent Horn.
- All ABS Body – Sturdy but Light Weight. High Efficiency & Clear sound.
- Operates on UM-3 (AA) Pencil cells.
- Microphone with volume control and Push type ON/OFF Switch.
- Power ON LED indication provided.



PM-99®

25 WATTS ■ Super Power Megaphone

- Operates on UM-1 (large) Dry Cells & 12V Car Battery.
- Longer Battery Life due to special design for low current consumption.
- Loud & Clear Sound even at long distance.
- Additional Speaker can be externally connected for louder, distributed sound.
- Supplied with Microphone.

SPECIFICATIONS	AM-20HD	CLH-33	PM-99®
POWER OUTPUT	16W Rated/20W Max.	5W Rated/10W max.	16W Rated/25W max.
VOICE RANGE	Approx. 400m (Siren 500m) In Quiet Surroundings	—	Approx. 400m (Siren 500m) In Quiet Surroundings
POWER SOURCE	8 × UM-2 Cells Car Battery 12-14V DC	9V DC (6 x AA Pencil Cells) —	8 × UM-1 Cells Car Battery 12-14V DC
MICROPHONE	Unidirectional	Unidirectional	Unidirectional, 600 ohms
INPUTS	Built-in Microphone	Built-in Microphone	2 × Mic 4.5mV, 1 × Aux 60mV
DIMENSIONS	Horn Ø220mm, L370 mm	Horn Ø185mm, L300 mm	W230 × H320 × D220 mm
WEIGHT	1.90kg (without cells)	1.00kg (with cells)	4.00kg



CCS-2300

AC Operation



CCS-2300, a two-way counter communication system, exclusively designed for easy and effective conversation across counters with transparent security barriers. It consists of an attendant unit, a customer unit and a power supply unit, which are easy to install and simple to connect through dedicated cables as supplied with the system.

- Unique design, pleasing aesthetics & rugged construction.
- Two-way, hands-free communication.
- Easy, hassle-free installation.
- Compact & elegant table top attendant unit with 508mm (20") long gooseneck microphone for strain-free usage.
- A 3.5mm jack socket is provided for connecting a headband microphone like Ahuja HBM-50. This is useable by the attendant as an alternate to the fixed gooseneck microphone.
- Separate controls for adjusting the speech levels during Talk & Listen modes of operation.
- Special Auto-Mute ON/OFF option provided through a toggle switch. In Auto-Mute ON condition, the customer's microphone is partially muted if it is not used for 30 sec. approx. This facility prevents the attendant from being disturbed by unwanted outside noise.
- The customer's unit has an efficient speaker and a sensitive condenser cartridge, mounted in a beautifully designed housing.
- Attendant's microphone has voice priority over the customer's microphone.
- Power Supply CCS-2300P is BIS approved.



SPECIFICATIONS

CCS-2300

Output	2W (Max.) in each amplifier
Microphone Element	Electret Condenser in both the units.
Auto Mute 'ON'	Enables after 30 seconds (approx.)
Power Requirement	AC: 220-240V, 50/60Hz
Protections	AC Fuse 1 × 0.5A
Dimensions	
Attendant Unit	W116 x H65 x D170 mm (w/o gooseneck)
Customer Unit	Ø98 x D52mm
Power Supply Unit	W85 × H58 × D150 mm
Weight	
Attendant Unit	1.30kg
Customer Unit	480g
Power Supply Unit	930g
Accessories	1 No. of fuse 0.5A, 2 Nos. of M4 moulded screws, 2 Nos. of self adhesive DUAL LOCK tape, 4.5mtrs. of interconnecting cable for Customer unit

CCS-2200 AC Operation



- Unique design, pleasing aesthetics & rugged construction.
- Duplex communication technology, ideal for ticket counters, enquiry counters, banks, embassies, hospitals etc.,. Wherever two way communication is required across a glass barrier. (Can also be used for one way communication).
- Compact & elegant attendant unit with 406.4mm (16") long gooseneck microphone, in black colour finish, for flexible sound pickup angle.
- Separate switches for switching the Host Unit mic, or the External Unit mic, ON or OFF.
- Separate volume controls on the Host Unit for adjusting the audio output level of the Host Unit and the External Unit.
- Host Unit mic has automatic voice priority over the External Unit mic. When attendant is speaking into the Host Unit mic, the mic of the External unit is automatically muted.
- Exclusively designed lightweight plastic external unit, which can be easily mounted on any flat surface. Double sided fixing pad provided.
- External unit houses a condenser mic cartridge and an efficient speaker for clear and intelligible sound outside the glass barrier.
- Audio output for recording available through 3.5mm phone jack on the Host Unit. This is a stereo output having signals from both the Host Unit mic and the External Unit mic.
- A 3.5mm phone jack is provided on the rear panel of the Host Unit for Line Input. This feature can be used to play back pre-recorded messages through the external unit speaker by connecting the Pre-amp output or Line Output of any Ahuja amplifier to the Line Input of the Host Unit.
- The system is easy to install and simple to operate.
- The Host Unit is a table top unit which operates on 12V DC, through an AC adapter supplied alongwith.

SPECIFICATIONS	CCS-2200
OUTPUT	2W (Max.) in each amplifier
MICROPHONE ELEMENT	Electret Condenser in both the units
POWER REQUIREMENT	AC: 220-240V, 50/60Hz
PROTECTIONS	4Ω each
DIMENSIONS	
Attendant Unit	W180 x H130 x D57mm
Customer Unit	W118 x H84 x D39mm
WEIGHT	
Attendant Unit	590g
Customer Unit	190g
Accessories	1 No. Attendant (Host) Unit, 1 No. Customer (Ext.) Unit, 1 No. AC adapter, 1 No. self adhesive Tape, 1 No. rubber strip



PA Microphone and Speaker Stands

PA MICROPHONE STANDS

AHUJA Microphone stands employ sturdy mechanism ensuring trouble free movement and positioning of microphones. These stands are functional and resistant to corrosion, due to superior quality of chrome plating/powder coating. These stands are with 5/8" 27 TPI to match all AHUJA MICROPHONES.

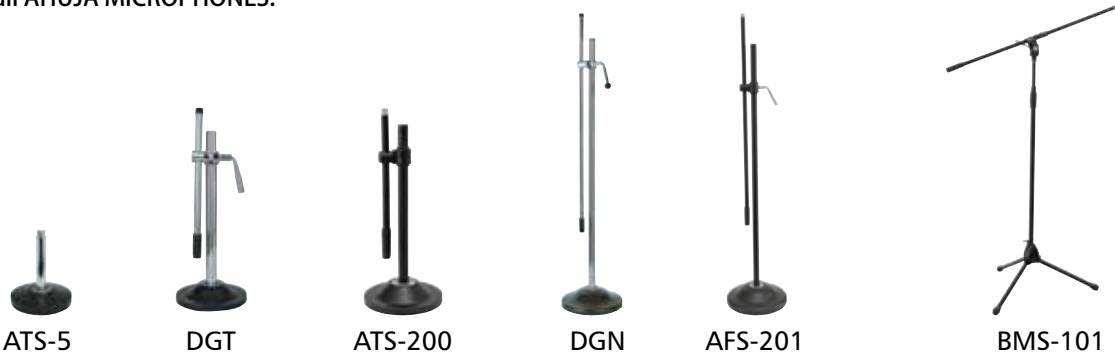

SPECIFICATIONS	ATS-5	DGT	ATS-200	DGN	AFS-201	BMS-101
TYPE	Table Stand	Table/Floor Stand	Table/Floor Stand	Floor Stand	Floor Stand	Boom Stand
HEIGHT	130 mm	350-530 mm	350-530 mm	920-1500 mm	920-1500 mm	1000-1700 mm
BASE DIA	120 mm	150 mm	150 mm	230 mm	230 mm	650 mm
WEIGHT	760g	2.20kg	2.22kg	4.60kg	4.41kg	2.16kg

PA SPEAKER STANDS & BRACKETS

Aluminium speaker stands designed for quick and easy installation. Equipped with rigid clamping system. A steel locking pin has been provided for extra safety, which gives secure positioning of elevated equipment. Coated with black powder paint for long life.

SPECIFICATIONS	STA-100	STA-150
Height Adjustment	762 mm (2½') - 1067 mm (3½')	1067 mm (3½') - 1981 mm (6½')
LOAD CAPACITY	25.0kg	40.0kg
WEIGHT	3.00kg	4.70kg



ALF-11

Flybar Frame

For ALX-11000



INSTALLATION CARE POINTS

1. Installation should be done by an authorised professional only.
2. Inspect the flybar, locking pins, brackets and hardware for any damages prior to rigging & suspending the system.
3. Usage of brackets, locking pins, flybar and hardware, as supplied with the system, is highly recommended.
4. Only competent personnel should be engaged for installation of trusses and flying the line array system.
5. Additional safety items like belts, chains etc. should always be used.

ALF-06

Flybar Frame

For ALX-6000



AWB-30

Wall Mount Bracket



INSTALLATION CARE POINTS

1. Recommended for use with AHUJA Moulded Cabinet PA Loudspeakers.
2. Inspect the locking pins, brackets and hardware for any damages prior to mounting.
3. Installation should be done by an authorised professional only.

CONNECTORS

There are various connectors used with the Ahuja range of PA Products.

1. RCA Phono Plug

A popular audio connector used on auxiliary inputs & booster in/out connections; also commonly used on mixers, CD & tape players. They are wired using single core screened cable.

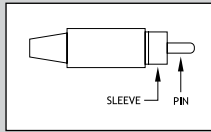

2. XLR Plug

This is the industry standard microphone connector; robust and relatively simple to install. There are a number of ways in which they can be wired.

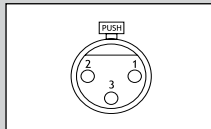

Balanced Operation

Pin 1 connects to screen (Signal earth)
Pin 2 connects to signal + (Live)
Pin 3 connects to signal - (Return)

Quasi Balanced Operation

Pins 1 & 3 connects to the screen of the cable
Pin 2 connects to signal conductor.

The Pin numbers are identified on the XLR plug and an easy way to remember how they should be wired is:

- X = Earth (Pin 1)
- L = Live (Pin 2)
- R = Return (Pin 3)

3. 6.3mm (1/4") Phone Plug

There are two versions of this connector in common use, MONO & STEREO.

The STEREO plug is used for BALANCED operation and wired as follows:

- TIP - Signal +
- RING - Signal -
- SLEEVE - Screen

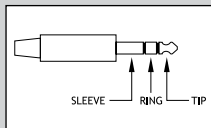

The MONO plug is used for UNBALANCED operation and wired as follows:

- TIP - Signal +
- SLEEVE - Screen

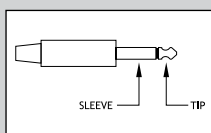

The MONO plug is also used for QUASI-BALANCED operation and is wired as follows:

- TIP - Signal +
- SLEEVE - Signal -, Screen

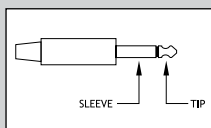

4. SPEAKON Plug

This is used in some models of Ahuja speaker systems for connecting to an amplifier. The pin configurations are as shown in the diagram:

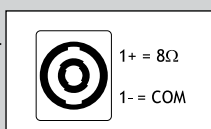

LOUDSPEAKER CABLE SIZE & CONNECTIONS

100V LINE

When installing a 100V line system, it is important that the correct size of cable is used to connect the speakers to the amplifier. The following chart gives an indication of the maximum cable length which can be used for each type of cable (cables specified by number & diameter of wire in mm).

100V Amp	24/0.2	32/0.2	48/0.2	80/0.2	128/0.2	122/0.25
30W	800m	1066m	1600m	2666m	4266m	6400m
60W	400m	533m	800m	1333m	2133m	3200m
120W	200m	266m	400m	666m	1066m	1600m
240W	100m	133m	200m	333m	533m	800m

As the voltage on the line can approach 100 volts, installation must follow best practice with double insulated cable being used. Cable runs should be kept away from any potential source of interference such as 3 phase mains, data, telecom cables etc.

100V Line System must always be wired in PARALLEL:

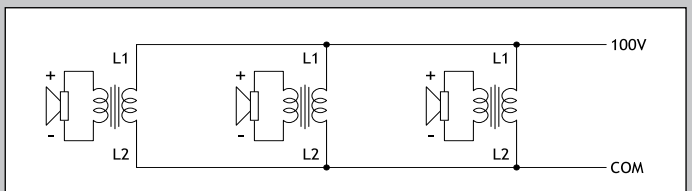

NOTE: The total load presented to the amplifier must not exceed the rated output of the amplifier or damage can result.

LOW IMPEDANCE

All the amplifiers in the Ahuja range have the facility for connection of low impedance loudspeakers. On low impedance, to minimize power losses, short cable runs are recommended. Where it is intended to use multiple low impedance speakers to cover an area, the speakers must be wired in a series/parallel arrangement in such a way to present the correct load to the amplifier.

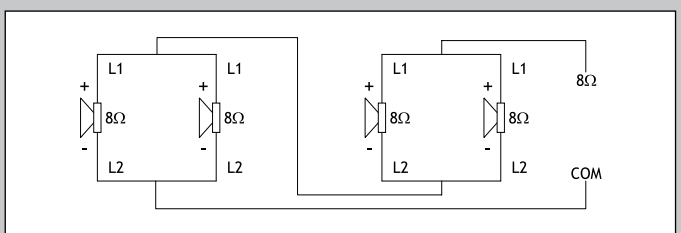

NOTE: The total load impedance presented to the amplifier must never be below the rated amplifier impedance, otherwise damage can result. To avoid damage to the speakers the total wattage of the driver units should be at least 30% higher than the rated power output of the amplifier.

You must NEVER mix 100V line and low impedance speakers on the same system.



IP DEGREES OF PROTECTION

IP protection is given as two figures.

For example: IP66

The 1st numeral (6) - Dust tight. No ingress of dust.

The 2nd numeral (6) - Protected against heavy seas, or water projected in powerful jets shall not enter the enclosure.

1st Numeral: Protection of persons and from solid objects

1		Protected against solid objects greater than 50 mm Ø Can not touch the live part in the enclosure with hand.
2		Protected against solid objects greater than 12 mm Ø Can not touch the live part in the enclosure with finger tip.
3		Protected against solid objects greater than 2.5 mm Ø Can not touch the live part in the enclosure with tools, wires.
4		Protected against solid objects greater than 1.0 mm Ø Can not touch the live part in the enclosure with tools, wire.
5		Dust protected. Ingress of dust is not totally prevented but satisfactory operation of the equipment is available.
6		Dust tight. No ingress of dust.

2nd Numeral: Protection from ingress of water

1		Protected against dripping water.
2		Protected against dripping water when tilted upto 15°.
3		Protected against spraying water at angle up to 60° from the vertical.
4		Protected against splashing water from any direction.
5		Protected against water jets by a nozzle against the enclosure from any direction.
6		Protected against heavy seas or water projected in powerful jets shall not enter the enclosure.
7		Protected against the effects on immersion.
8		Protected against submersion.

KEY TO SYMBOLS USED

2-Zone Operation	Supercardioid	Two Speakers 12"
19" Rack Mounting	Omnidirectional	One Speaker 12"
Telephone Input	IP Rating	Two Way Speaker System
Headphone Output	100V Line	Subwoofer
CLASS-D AMPLIFIER	Double Insulated	Compliance to EU Standards
Unidirectional Cardioid	Weatherproof	NEW! New Product

GENERAL INSTALLATION PRECAUTIONS

DO NOT run microphone cables near mains, data, telephone or 100V line cables.

DO NOT run 100V line cables near data, telephone or other low voltage cables.

DO NOT exceed 90% of the amplifier's output power when using 100V line (speech only).

DO NOT exceed 70% of the amplifier's output power when using 100V line (high level music or voice).

DO NOT over-drive the mic inputs. (In certain PA applications an extremely high speech signal is fed to the microphone. This results in a highly distorted output, thereby damaging driver unit/speaker voice coil). For such applications connect the microphone through an attenuator to the amplifier.

ALWAYS keep 'Microphone' Volume Control and 'Master' Volume Control of the Amplifier at position '6' or below.

DO NOT use 100V line and low impedance speaker connections to the same amplifier.

AVOID jointing the microphone cable; when this is unavoidable make sure a good screened connector is used, e.g. XLR.

ENSURE that all loudspeakers are in-phase.

ENSURE that there are no short circuits on the loudspeaker line before connection to the amplifier.

RELATIVE NOISE LEVELS IN Decibels

dB	Comment
120	Threshold of pain. Jet taking off at 60m
115	Pneumatic drill, express train passing through station
110	Impossible to converse. Disco (on dance floor)
105	Live orchestra
100	Inside underground railway station
95	Machine shop, print shop
90	Difficult to converse. Ventilation equipment room, club
85	Busy supermarket
80	Loud voice needed to talk, Traffic noise, church choir
75	Noisy office
70	Speech at 30cm, typing pool, theatre, department store
65	Typical office, normal talking, near motorway
55	Background noise, hotel lobby, restaurant
50	Light traffic at 30m, quiet office
45	Tearing paper at 1m
40	Average residential area, quiet house
35	Soft music
30	Countryside
25	Library
20	Leaves rustling
15	Broadcasting studio
10	Quiet whisper at 1m
0	Threshold of hearing. Minimum audible sound

WARNING

In the market **SPURIOUS/DUPLICATE** sub-standard Amplifiers, Microphones, Driver Units, Horns, Diaphragms are being passed off as genuine AHUJA Products.

BE VERY CAREFUL

- Obtain your requirements from **AUTHORISED AHUJA DEALERS** only.
Insist on seeing the 'AUTHORISED DEALER CERTIFICATE' and **AHUJA** / **ANA** 'TRADE MARK'
- Manufacture & Sale of Spurious/Duplicate Products is Illegal and Punishable Under Law.

INDEX

5050-DP	50	APT-025.....	127	AUD-99XLR	69
A		AS12-X100	120	AWB-30.....	146
ABA-4000.....	135	AS15-X200	120	AWM-495V1	78
ABA-5000.....	134	ASC-20T	89	AWM-495V2	77
ABM-301H	81	ASC-310T	89	AWM-495VHL	78
ABM-301M.....	81	ASC-315T	89	AWM-520V2	76
ABW-400UH	75	ASC-320T	89	AWM-520VH	77
ABW-400UL.....	75	ASC-40T	89	AWM-520VHL	76
ACM-96.....	82	ASM-580XLR	68	AWM-520VL.....	77
ACM-96CH	82	ASM-780XLR	68	AWM-630VG.....	79
ACX-202	128	ASM-980XLR	68	AWM-700U2	73
ADJ-300	62	ASX-312B	96	AWM-700UH.....	74
ADM-311	70	ASX-312BT.....	96	AWM-700UHL	73
ADM-411	69	ASX-312W	96	AWM-700UL.....	74
ADM-511	69	ASX-312WT	96	B	
ADP-30R.....	40	ASX-612B	96	BMS-101	146
AFS-201.....	146	ASX-612BT.....	96	BR-250M	29
AFT-24F2M.....	63	ASX-612W	96	BS-6082T.....	94
AGE-31X2.....	63	ASX-612WT	96	BS-6083T.....	94
AGN-480	80	ASX-912B	96	BS-6462T.....	90
AGN-500	80	ASX-912BT.....	96	BTA-660	137
ALA-2400	117	ASX-912W	96	BTA-880	136
ALF-06.....	146	ASX-912WT	96	BTZ-10000.....	21
ALF-11	146	AT-06.....	99	BTZ-7000.....	21
ALX-11000.....	119	AT-20.....	99	C	
ALX-6000.....	118	AT-40.....	99	C-1000/450	129
AM-20HD	143	ATH-22	88	C-100HF	130
AM-21SD.....	142	ATS-200.....	146	C-1300/750	130
AM-22HSD	142	ATS-5.....	146	C-300/200	128
AM-24DP.....	142	AU-35.....	84	C-350/450	128
AMA-240DP	39	AU-40.....	84	C-500/450	128
AMH-402T.....	87	AU-40XT.....	84	C-500/750	129
AMX-1412	59	AU-50XT.....	84	C-600/450	129
AMX-812	59	AU-60.....	84	C-650/750	129
AMX-912.....	60	AUD-100XLR	68	C-650SW	130
AMX-912DP.....	60	AUD-101XLR	68	C-80HF	130
APA-240	38	AUD-54	71	CCS-2200	145
APA-480	38	AUD-59XLR	71	CCS-2300	144
APM-201RM.....	52	AUD-65XLR	70	CD-100.....	126
APM-202CU.....	53	AUD-70XLR	70	CD-50S.....	126
APS-482	82	AUD-77DX.....	70	CD-80S.....	126
APT-001.....	127	AUD-97XLR	69	CDH-200	127
APT-016.....	127	AUD-98XLR	69		
		AUD-99MS	70		

INDEX

CDH-800	127	DPA-770M	48	LXA-3200	18
CLH-33	143	DX12-F200	121	LXA-4500	17
CMA-4400	13	DXA-3502	20	LXA-6000	17
CMA-5400	10	DZ12-F200	121	LXA-7600	16
CMB-4500	13				
CMC-4100	14	E		M	
CMC-5100	11	EHC-10	84	MM-60M	82
CMD-4200	14	EHC-10XT	84	MMX-55	62
CMD-5200	11	EWM-100	72	MPA-40S	37
CMS-4300	14			MTP-20	82
CS-3061T	91	F		MX-15	62
CS-451T	90	FMX-106	61		
CS-5061T	91	FMX-106DP	61	N	
CS-6081T	91			NBA-15	139
CS-662T	90	G		NBA-20DP	139
CS-663T	90	G-611S	80	NBA-30WL	139
CS-8151T	91	G-622S	80		
CSA-20	9	GM-601LM	80	O	
CSD-5201T	93	GM-605	80	OSX-666T	99
CSD-6303T	93	GM-611M	80		
CSD-8401T	93	GM-615	80	P	
CSM-990	71	GMB-6C	80	PA-200DS	37
CSX-3081T	92	GN-45	9	PA-200S	37
CSX-5081T	92	GS-6401T	98	PA-400DS	36
CSX-6101T	92			PA-400S	36
CTP-10DX	72	H		PGB-48	81
CUM-450	71	HBM-50	72	PGM-481	81
CWM-400V	79	HBM-60CC	72	PM-99	143
CWS-8100C	9			PMX-1032DFX	58
CWS-8200D	9	L		PMX-1032FX	58
CWS-8300R	8	L12-MB200	122	PMX-1632FX	57
		L12-MB300	122	PRO+ 3200	66
D		L15-MB300	122	PRO+ 3400	66
DA-80	40	L15-MB400	123	PRO+ 7500du	66
DA-88	40	L15-MB500	123	PRO-2200SC	67
DGN	146	L15-MB650	123	PROMIX-1442	56
DGT	146	L18-SW1000	125	PS-300T	95
DIAPHRAGMS	88	L18-SW1300V	125	PS-400T	95
DM-440	67	L18-SW1300X	125	PS-500T	95
DM-740	67	L18-SW650	124	PSX-302DP	133
DMX-22	64	L18-SW800	124		
DMX-44	64	LXA-1400	19	R	
DPA-370	49	LXA-2000	19	RMX-1700	39
DPA-570M	49	LXA-2400	18	SAX-200DX	103

INDEX

SAX-300DX.....	104	SSA-250DP.....	46
SCM-15.....	88	SSA-250FX.....	32
SCM-15T.....	88	SSA-250M.....	32
SCM-30.....	88	SSA-350.....	31
SCM-30T.....	88	SSA-5000DP.....	46
SHM-1000XLR.....	67	SSA-5000EM.....	31
SK-12FRX.....	121	SSA-7000.....	30
SK-12FRZ.....	121	SSB-120.....	33
SK-15FRX.....	121	SSB-120DP.....	47
SK-15FRZ.....	121	SSB-45EM.....	35
SMS-450.....	109	SSB-60EM.....	34
SMS-450P.....	110	SSB-80DFM.....	48
SMX-302T.....	97	SSB-80M.....	34
SMX-602T.....	97	SSB-85FX.....	34
SMX-902T.....	97	SSW-16M.....	54
SP-5251T.....	98	STA-100.....	146
SP-6305TD.....	98	STA-150.....	146
SPA-10000.....	28	SUB-300A.....	112
SPA-15000.....	28	SUH-15.....	85
SPA-25000.....	27	SUH-15XT.....	86
SPA-5000EM.....	29	SUH-25.....	85
SPX-1200.....	107	SUH-25XT.....	86
SPX-1210.....	107	SUH-40.....	85
SPX-400DX.....	104	SUH-40XT.....	86
SPX-450.....	105	SWX-1000.....	113
SPX-610.....	105	SWX-1300DX.....	114
SPX-800.....	106	SWX-2100.....	115
SPX-810.....	106	SWX-2600.....	116
SQX-850.....	103	SWX-650.....	113
SRM-120.....	108	SWX-810.....	113
SRM-220.....	108		
SRX-120DXM.....	100	T	
SRX-200.....	100	TRINITY-411.....	71
SRX-220.....	101	TZA-1200.....	24
SRX-250DXM.....	101	TZA-1500.....	24
SRX-440.....	101	TZA-1500DP.....	45
SRX-500.....	102	TZA-2000.....	23
SRX-50DX.....	100	TZA-2000DP.....	45
SRX-50XT.....	100	TZA-4000DPM.....	44
SRX-510.....	102	TZA-4000EM.....	23
SSA-10000.....	30	TZA-7000.....	22
SSA-100M.....	33	TZA-7000DP.....	44
SSA-160DP.....	47		
SSA-160EM.....	33		

U	
UB-30M.....	36
UBA-1300.....	25
UBA-500DP.....	43
UBA-500M.....	26
UBA-800.....	26
UBA-800DP.....	43
UHC-15.....	85
UHC-15XT.....	86
UHC-25.....	85
UHC-25XT.....	86
UHC-30.....	85
UHC-30XT.....	86
UTP-30.....	72
UTR-30E.....	35
UTR-40.....	35

V	
VIVA-600.....	140
VX-200.....	111
VX-300.....	111
VX-400.....	111

W	
WFA.....	88
WFB.....	88
WP-220M.....	138
WS-6255T.....	94
WS-661T.....	94
WS-664T.....	94
WSL-2500R.....	141
WSX-551T.....	94

X	
XPA-1510DP.....	133
XPA-3010DP.....	132

Z	
ZXA-500DP.....	42

For Religious Places Outdoor Gatherings Announcements DJs Railway Stations
Airports Food Courts Stadiums Auditoriums Hospitals Conferences Offices
Shopping Malls Hotels Channel Music High Rise Buildings Parking Lots
Restaurants Pubs Schools Gymnasiums Petrol Pumps Stage Shows Coaching
Institutes Crowd Control Discourses Paging Sound Professionals and many more



The Most Admired Indian Manufactured Electronics Brand
Awarded by ELCINA in 2015

For further details, please contact:

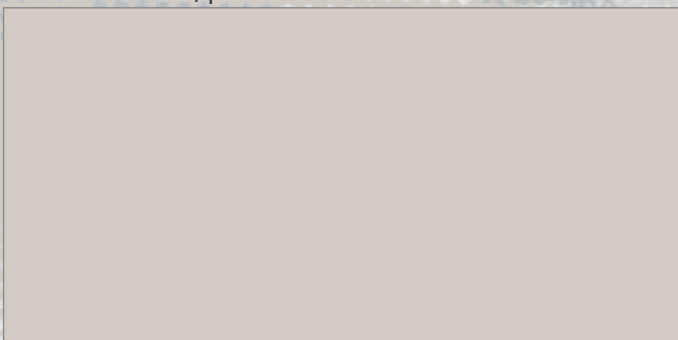

Design and Specifications are subject to change without notice owing to continuous product up-gradation.

Technical specifications are subject to production tolerances.

We cannot be held responsible for printing errors, should they occur.

AHUJA and **ANA** are registered trademarks of Ahuja Radios in India and other countries.

© Copyright Ahuja Radios, 2021. All rights reserved. Any unauthorized reproduction or use of logos, images or design elements is strictly prohibited by law. No part of the compilation may be reproduced in any manner or translated without written permission.

Ahuja Products manufactured by:

AHUJA RADIOS

215, Okhla Industrial Estate, New Delhi-110 020, India

Tel: +91-11-26831549/41612474 Fax: +91-11-26847287/41616563

E-mail: marketing@ahujaradios.com

For Enquiries (within India): marketing@ahujaradios.com

For International Enquiries (from outside India): intl.trade@ahujaradios.com

AHUJA RADIOS, C-45, Phase-II, Noida-201305 (UP)

TRUSOUND PVT. LTD., C-89, Sector IV, Noida-201301 (UP)



An ISO 9001:2015 Co.

www.ahujaradios.com